



HP EliteBook 820 G2 Notebook PC and HP EliteBook 720 G2 Notebook PC

Maintenance and Service Guide

© Copyright 2015 Hewlett-Packard
Development Company, L.P.

Intel and Core are trademarks of Intel Corporation in the U.S. and other countries. Microsoft and Windows are U.S. registered trademarks of Microsoft Corporation. SD Logo is a trademark of its proprietor.

The information contained herein is subject to change without notice. The only warranties for HP products and services are set forth in the express warranty statements accompanying such products and services. Nothing herein should be construed as constituting an additional warranty. HP shall not be liable for technical or editorial errors or omissions contained herein.

First Edition: January 2015

Document Part Number: 791152-001

Product notice

This guide describes features that are common to most models. Some features may not be available on your computer.

Not all features are available in all editions of Windows 8. This computer may require upgraded and/or separately purchased hardware, drivers, and/or software to take full advantage of Windows 8 functionality. See <http://www.microsoft.com> for details.

Software terms

By installing, copying, downloading, or otherwise using any software product preinstalled on this computer, you agree to be bound by the terms of the HP End User License Agreement (EULA). If you do not accept these license terms, your sole remedy is to return the entire unused product (hardware and software) within 14 days for a refund subject to the refund policy of your place of purchase.

For any further information or to request a full refund of the computer, please contact your local point of sale (the seller).

Safety warning notice

⚠ WARNING! To reduce the possibility of heat-related injuries or of overheating the device, do not place the device directly on your lap or obstruct the device air vents. Use the device only on a hard, flat surface. Do not allow another hard surface, such as an adjoining optional printer, or a soft surface, such as pillows or rugs or clothing, to block airflow. Also, do not allow the AC adapter to contact the skin or a soft surface, such as pillows or rugs or clothing, during operation. The device and the AC adapter comply with the user-accessible surface temperature limits defined by the International Standard for Safety of Information Technology Equipment (IEC 60950-1).

Table of contents

1 Product description	1
Product Name	1
Chipset	1
Processor	1
Panel	1
Graphics	2
Memory	2
Flash cache	2
MiniCard solid-state drive	2
Primary storage	3
Audio and video	3
Ethernet	4
Wireless networking	4
External expansion	4
Ports	5
Docking	5
Keyboard/pointing devices	5
Power requirements	5
Security	6
Operating system	6
Serviceability	8
2 External component identification	9
Display	9
Front	10
Left	11
Top	13
TouchPad	13
Lights	14
Buttons, speakers, and fingerprint reader (select models only)	15
Keys	16
Right	17
Bottom	19
Locating the serial number, product number, and model number	20

3 Illustrated parts catalog	21
Computer major components	21
Display assembly components	27
Plastics Kit	29
Mass storage devices	30
Miscellaneous parts	31
Sequential part number listing	33
4 Removal and replacement preliminary requirements	41
Tools required	41
Service considerations	41
Plastic parts	41
Cables and connectors	42
Drive handling	42
Grounding guidelines	42
Electrostatic discharge damage	42
Packaging and transporting guidelines	44
Workstation guidelines	44
5 Removal and replacement procedures for Customer Self-Repair parts	46
Component replacement procedures	46
Service cover	46
Battery	48
Hard drive	50
WWAN module	53
Solid-state drive	55
WLAN module	57
Memory module	59
Keyboard	60
6 Removal and replacement procedures for Authorized Service Provider parts	65
Component replacement procedures	65
Unlocking the device and disabling Always On Remote Management (select HP devices only)	65
RTC battery	66
Top cover	67
Display assembly	71
TouchPad	78
NFC module	79
Card reader board	80
Heat sink	82

Fan	84
System board	86
Fingerprint reader board	89
Speaker assembly	90
Power button board	92
7 Computer Setup (BIOS), MultiBoot, and HP PC Hardware Diagnostics (UEFI) in Windows 8.1	93
Using Computer Setup	93
Starting Computer Setup	93
Navigating and selecting in Computer Setup	93
Restoring factory settings in Computer Setup	94
Updating the BIOS	95
Determining the BIOS version	95
Downloading a BIOS update	95
Using MultiBoot	96
About the boot device order	96
Choosing MultiBoot preferences	96
Setting a new boot order in Computer Setup	96
Dynamically choosing a boot device using the f9 prompt	97
Setting a MultiBoot Express prompt	97
Entering MultiBoot Express preferences	98
Using HP PC Hardware Diagnostics (UEFI)	98
Downloading HP PC Hardware Diagnostics (UEFI) to a USB device	98
Using HP Sure Start (select models only)	99
8 Computer Setup (BIOS), MultiBoot, and HP PC Hardware Diagnostics (UEFI) in Windows 7	100
Using Computer Setup	100
Starting Computer Setup	100
Navigating and selecting in Computer Setup	100
Restoring factory settings in Computer Setup	101
Updating the BIOS	101
Determining the BIOS version	101
Downloading a BIOS update	102
Using MultiBoot	103
About the boot device order	103
Choosing MultiBoot preferences	103
Setting a new boot order in Computer Setup	103
Dynamically choosing a boot device using the f9 prompt	104
Setting a MultiBoot Express prompt	104
Entering MultiBoot Express preferences	104
Using HP PC Hardware Diagnostics (UEFI) (select models only)	104

Downloading HP PC Hardware Diagnostics (UEFI) to a USB device	105
9 Specifications	106
10 Backup and recovery in Windows 8.1	107
Backing up your information	107
Performing a system recovery	107
Using the Windows recovery tools	107
Using f11 recovery tools	108
Using Windows operating system media (purchased separately)	109
Using Windows Refresh or Windows Reset	109
Using HP Software Setup	109
11 Backup and recovery in Windows 7	110
Creating recovery media and backups	110
Guidelines	110
Creating recovery media with HP Recovery Disc Creator	110
Creating recovery media	111
Backing up your information	111
Performing a system recovery	112
Using the Windows recovery tools	112
Using f11 recovery tools (select models only)	113
Using Windows 7 operating system media	113
12 Statement of memory volatility	115
Nonvolatile memory usage	117
Questions and answers	119
Using HP Sure Start (select models only)	120
13 Power cord set requirements	121
Requirements for all countries	121
Requirements for specific countries and regions	121
14 Recycling	123
Index	124

1 Product description

Product Name

Description	720 G2 models	820 G2 models
HP EliteBook 720 G2 Notebook PC	x	
HP EliteBook 820 G2 Notebook PC		x

Chipset

Description	720 G2 models	820 G2 models
Intel® processor controller hub (PCH), soldered on circuit (SoC)	x	x

Processor

Description	720 G2 models	820 G2 models
5th Generation Intel® processors:	x	x
<ul style="list-style-type: none">Intel Core i3-5010U 2.1-GHz 3-MB L3 Cache, 15WIntel Core i5-5200U 2.2-GHz (max turbo frequency 2.7-GHz), 3 MB L3 cache, 15WIntel Core i5-5300U 2.3-GHz (max turbo frequency 2.9-GHz), 3-MB L3 Cache, 15W		
<ul style="list-style-type: none">Intel Core i7-5500U 2.4-GHz (max turbo frequency 3.0-GHz), 4-MB L3 Cache, 15WIntel Core i7-5600U 2.6-GHz (max turbo frequency 3.2-GHz), 4-MB L3 Cache, 15W		x

Panel

Description	720 G2 models	820 G2 models
12.5" high definition (HD), AntiGlare (AG), light-emitting diode (LED), SVA, 45% CG, 200 nits, eDP 1.2, flat, (1366x768)	x	x
12.5" HD AG SVA 45% CG 200 nits eDP 1.2 flat (1366x768) with camera		
12.5" FHD AG UWVA 50% CG 300 nits eDP 1.3 ultra slim (1920 x 1080)		
12.5" FHD AG UWVA 50% CG 300 nits eDP 1.3 ultra slim (1920 x 1080) with camera		
12.5" FHD UWVA 50% CG 300 nits eDP 1.3 ultra slim (1920 x 1080) capacitive touch enabled with camera (includes chemically-strengthened Gorilla Glass 3 top cover)		

Graphics

Description	720 G2 models	820 G2 models
Intel HD Graphics 5500	x	x
UMA configurations support up to 3 displays through the Quest 2 Dock		

Memory

Description	720 G2 models	820 G2 models
Two customer-accessible/upgradable memory module slots	x	x
Support for DDR3L 1600-MHz PCL3-12800 dual channel memory		
Support for 16384-MB of system memory in the following configurations:		
<ul style="list-style-type: none">16384-MB total system memory (8192 MB × 2)12288-MB total system memory (8192 MB + 4096 MB)8192-MB total system memory (4096 MB × 2 or 8192 MB × 1)6144-MB total system memory (4096 MB + 2048 MB)4096-MB total system memory (4096 MB × 1 or 2048 MB × 2)2048-MB total system memory (2048 MB × 1)		

Flash cache

Description	720 G2 models	820 G2 models
Support for 32-GB solid-state drive (M.2 form factor)	x	x
Intel SRT (Smart Response Technology)		

MiniCard solid-state drive

Description	720 G2 models	820 G2 models
256-GB solid-state drive (2260/PCIe M.2 form factor)	x	x
120-GB solid-state drive (2242/SATA-3 M.2 form factor)		

Primary storage

Description	720 G2 models	820 G2 models
Support for 6.35-cm (2.5-in) hard drives in 7.0-mm (.28-in) thickness	x	x
Support for the following hard drive:	x	x
<ul style="list-style-type: none"> 1-TB, 5400-rpm, SATA, 7.0-mm hard drive 500-GB, 7200-rpm, SATA, 7.0-mm hard drive 500-GB, 7200-rpm, SED, 7.0-mm hard drive 500-GB, 5400-rpm, SATA, SED, FIPS-140-2, 7.0-mm hard drive 320-GB, 7200-rpm, SATA, 7.0-mm hard drive 		
Support for the following 6.35-cm (2.5-in) solid-state drives:	x	x
<ul style="list-style-type: none"> 512-GB, SATA-3, solid-state drive 256-GB, SATA-3, SED, Opal 1, solid-state drive 256-GB, SATA-3, SED, Opal 2, solid-state drive 256-GB, SATA-3, TLC, solid-state drive 240-GB, SATA-3, solid-state drive 180-GB, SATA-3, SED, Opal 2, solid-state drive 180-GB, SATA-3, SED, Opal 1, solid-state drive 180-GB, SATA-3, solid-state drive 128-GB, SATA-3, solid-state drive 128-GB, SATA-3, TLC, solid-state drive 		
<ul style="list-style-type: none"> 512-GB, SATA-3, SED, Opal 2, solid-state drive 		x

Audio and video

Description	720 G2 models	820 G2 models
Webcam, 720p	x	x
Supports “No camera” option		
Dual array microphones		
Stereo speakers (2)		
Realtek ALC3228 HD audio with DTS Studio sound		

Ethernet

Description	720 G2 models	820 G2 models
Intel I218LM Gigabit Network Connection with iAMT	x	x
S3/S4/S5 wake on LAN		

Wireless networking

Description	720 G2 models	820 G2 models
Integrated wireless local area network (WLAN) options by way of wireless module	x	x
Two WLAN antennas built into display assembly		
Support for the following WLAN formats:	x	x
<ul style="list-style-type: none">Intel Dual Band Wireless-AC 3160Intel Dual Band Wireless-AC 7265 802.11 ac 2x2 WiFi + Bluetooth 4.0 WLAN moduleIntel Dual Band Wireless-N 7265AN 802.11 a/b/g/n 2x2 WiFi + Bluetooth 4.0 Combo Adapter		
Integrated wireless wide area network (WWAN) options by way of wireless module (select models only)	x	x
Two WWAN antennas built into display assembly (select models only)		
Support for the following WWAN formats:	x	x
<ul style="list-style-type: none">HP hs3110 HSPA+ Mobile Broadband ModuleHP lt4112 LTE/HSPA+ Mobile Broadband ModuleHP lt4111 LTE/EV-DO/HSPA+ Mobile Broadband Module		
Integrated NFC module	x	x
NFC antenna		
Supports "No NFC" option		

External expansion

Description	720 G2 models	820 G2 models
SD media reader slot	x	x
Support for SD, SDHC, SDXC		
Push-push insertion/removal		
SIM slot (populated with WWAN; tool-less user-accessible)		

Ports

Description	720 G2 models	820 G2 models
<ul style="list-style-type: none">AC adapter, HP Smart AdapterAudio-in (mono microphone)/audio-out (stereo headphone) combo jackDisplayPort 1.2DockingRJ-45 (Ethernet)USB 3.0 charging (1)USB 3.0 (2)VGA (Dsub 15 pin) supporting: 1920×1200 external resolution @ 75 Hz, hot plug and unplug and autodetection for correct output to wide-aspect vs. standard aspect video	x	x

Docking

Description	720 G2 models	820 G2 models
HP UltraSlim Docking Station	x	x
HP Docking Station		

Keyboard/pointing devices

Description	720 G2 models	820 G2 models
Dual point, spill-resistant (with drain) keyboard with DuraKeys, optional backlight	x	x
Touchpad Requirements: Glass with chemical etched surface, on/off button, support for 2-way scroll, Taps enabled as default, Gestures enabled by default (2-finger scrolling, 2-finger zoom (pinch))		

Power requirements

Description	720 G2 models	820 G2 models
Support for the following batteries:	x	x
<ul style="list-style-type: none">3-cell, 46-WHr, 4.15-AHr, Li-ion battery3-cell, 26-WHr, 2.37-AHr, Li-ion battery		
Support for the following AC adapters:		
<ul style="list-style-type: none">65-W HP Smart adapter EM		

Description	720 G2 models	820 G2 models
<ul style="list-style-type: none"> 45-W, 2-prong, 7.4 mm, DC jack AC adapter 45-W HP Smart adapter 		
Support for the following power cords:	x	x
<ul style="list-style-type: none"> 3-wire plug, 1.0 m 3-wire plug, 1.8 m 2-wire plug, 1.0 m 		

Security

Description	720 G2 models	820 G2 models
Support for the following:	x	x
<ul style="list-style-type: none"> Fingerprint reader Support for “No fingerprint reader” option Security Lock Integrated smart card reader (active) Trusted Platform Module (TPM) 1.2 (Infineon; soldered down) 		

Operating system

Description	720 G2 models	820 G2 models
Preinstalled:	x	
<ul style="list-style-type: none"> Microsoft® Windows® 8.1 Chinese Market 64-bit (available only with People's Republic of China country localization) Microsoft Windows 8.1 Emerging Market 64-bit Microsoft Windows 8.1 Multi-language 64-bit Microsoft Windows 8.1 Professional 64-bit DPK with Windows 7 Professional 64-bit Image Microsoft Windows 8.1 Professional 64-bit DPK with Windows 7 Professional 64-bit–MSNA Microsoft Windows 8.1 Professional 64-bit DPK with Windows 7 Professional 32-bit image Microsoft Windows 8.1 Professional 64-bit DPK with Windows 7 Professional 32-bit–MSNA Microsoft Windows 8.1 Core for Higher Education (ML) Microsoft Windows 8.1 Professional 64-bit Microsoft Windows 8.1 Professional 64-bit–MSNA Microsoft Windows 8.1 Professional for Education 64-bit 		

Description	720 G2 models	820 G2 models
<ul style="list-style-type: none"> • Microsoft Windows 7 Professional 32-bit, Service Pack 1 (available only if 4096-MB of total system memory [4096-MB × 1] or less is selected) • Microsoft Windows 7 Professional 64-bit, Service Pack 1 • Microsoft Windows 7 Professional 64-bit, Service Pack 1–MSNA • Ubuntu Linux (not available with WWAN or touch) • FreeDOS 2.0 		
Restore Media–DRDVD:		
<ul style="list-style-type: none"> • Microsoft Windows 8.1 (available with any Windows 8.1 operating system, required with any Windows 8.1 Professional downgrade operating system) • Microsoft Windows 7 (available with any Windows 7 or Windows 8.1 Professional downgrade operating system) 		
Restore Media–OSDVD:		
<ul style="list-style-type: none"> • Microsoft Windows 8.1 Professional (Update) 64-bit • Microsoft Windows 7 Professional 64-bit (available with any Windows 7 or Windows 8.1 Professional downgrade operating system) • Microsoft Windows 7 Professional 32-bit (available with any Windows 7 or Windows 8.1 Professional downgrade operating system) 		
Restore Media–SRDVD:		
<ul style="list-style-type: none"> • Ubuntu Linux 		
Certified:		
<ul style="list-style-type: none"> • Microsoft WHQL 		
Web-only support:		
<ul style="list-style-type: none"> • Microsoft Windows 8.1 Enterprise 64 • Microsoft Windows 8.1 Professional 64 • Microsoft Windows 8.1 Multi-language 64 • Microsoft Windows 8.1 Emerging Markets 64 • Microsoft Windows 8.1 Chinese Market 64 • Microsoft Windows 7 Enterprise 64 • Microsoft Windows 7 Enterprise 32 		

Serviceability

Description	720 G2	820 G2
End user replaceable parts:	x	x
<ul style="list-style-type: none">• AC adapter• Battery (system)• Hard drive• Keyboard• Memory module• Solid-state drive• WLAN module• WWAN module• M.2 (NGFF) Flash cache / SSD		

2 External component identification

Display

 **NOTE:** Your computer may look slightly different from the illustration in this section.







Component	Description
(1) WLAN antennas*	Send and receive wireless signals to communicate with wireless local area networks (WLAN).
(2) WWAN antennas* (select models only)	Send and receive wireless signals to communicate with wireless wide area networks (WWAN).
(3) Internal microphones	Record sound.
(4) Webcam light	On: The webcam is in use.
(5) Webcam	Records video and captures photographs. Some models allow you to video conference and chat online using streaming video. For information on using the webcam, access HP Support Assistant. To access HP Support Assistant, from the Start screen, select the HP Support Assistant app.
(6) Internal display switch	Turns off the display or initiates Sleep if the display is closed while the power is on. NOTE: The display switch is not visible from the outside of the computer.

*The antennas are not visible from the outside of the computer. For optimal transmission, keep the areas immediately around the antennas free from obstructions. For wireless regulatory notices, see the section of the *Regulatory, Safety, and Environmental Notices*

Component	Description
that applies to your country or region. To access this guide, from the Start screen, type <code>support</code> , and then select the HP Support Assistant app.	

Front







Component	Description
(1) 	<p>Wireless light</p> <p>On: An integrated wireless device, such as a wireless local area network (WLAN) device and/or a Bluetooth® device, is on.</p> <p>NOTE: On some models, the wireless light is amber when all wireless devices are off.</p>
(2) 	<p>Power light</p> <ul style="list-style-type: none"> On: The computer is on. Blinking: The computer is in the Sleep state, a power-saving state. The computer shuts off power to the display and other unneeded components. Off: The computer is off or in Hibernation. Hibernation is a power-saving state that uses the least amount of power. <p>NOTE: For select models, the Intel® Rapid Start Technology feature is enabled at the factory. Rapid Start Technology allows your computer to resume quickly from inactivity.</p>
(3) 	<p>AC adapter/Battery light</p> <ul style="list-style-type: none"> White: The computer is connected to external power and the battery is charged from 90 to 99 percent. Amber: The computer is connected to external power and the battery is charged from 0 to 90 percent. Blinking amber: A battery that is the only available power source has reached a low battery level. When the battery reaches a critical battery level, the battery light begins blinking rapidly. Off: The battery is fully charged.
(4) 	<p>Hard drive light</p> <ul style="list-style-type: none"> Blinking white: The hard drive is being accessed. Amber: HP 3D DriveGuard has temporarily parked the hard drive.

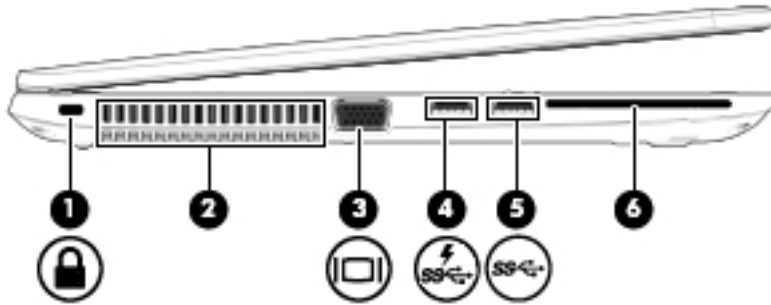

Left

 **NOTE:** Refer to the illustration that most closely matches your computer.

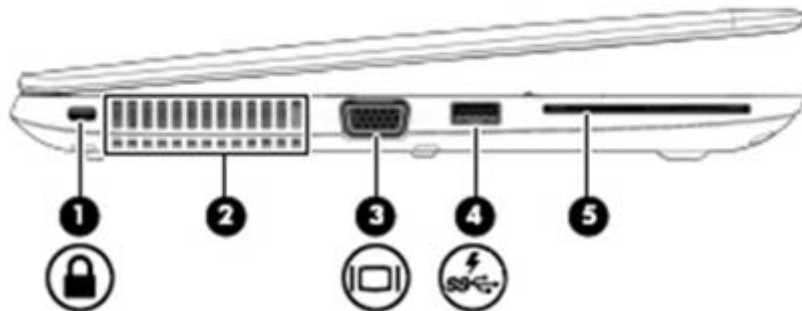

Component	Description
(1)  Security cable slot	Attaches an optional security cable to the computer. NOTE: The security cable is designed to act as a deterrent, but it may not prevent the computer from being mishandled or stolen.
(2) Vents	Enable airflow to cool internal components. NOTE: The computer fan starts up automatically to cool internal components and prevent overheating. It is normal for the internal fan to cycle on and off during routine operation.
(3)  External monitor port	Connects an external VGA monitor or projector.
(4)  USB 3.0 charging (powered) port	Connects an optional USB device, such as a keyboard, mouse, external drive, printer, scanner or USB hub. Standard USB ports will not charge all USB devices or will charge using a low current. Some USB devices require power and require you to use a powered port. NOTE: USB charging ports can also charge select models of cell phones and MP3 players, even when the computer is off.
(5)  USB 3.0 port	Connects an optional USB device, such as a keyboard, mouse, external drive, printer, scanner or USB hub.
(6) Smart card reader	Supports optional smart cards.



Component	Description
(1)  Security cable slot	Attaches an optional security cable to the computer. NOTE: The security cable is designed to act as a deterrent, but it may not prevent the computer from being mishandled or stolen.
(2) Vents	Enable airflow to cool internal components. NOTE: The computer fan starts up automatically to cool internal components and prevent overheating. It is normal for the internal fan to cycle on and off during routine operation.
(3)  External monitor port	Connects an external VGA monitor or projector.
(4)  USB 3.0 charging (powered) port	Connects an optional USB device, such as a keyboard, mouse, external drive, printer, scanner or USB hub. Standard USB ports will not charge all USB devices or will charge using a low current. Some USB devices require power and require you to use a powered port. NOTE: USB charging ports can also charge select models of cell phones and MP3 players, even when the computer is off.
(5) Smart card reader	Supports optional smart cards.

Top

TouchPad

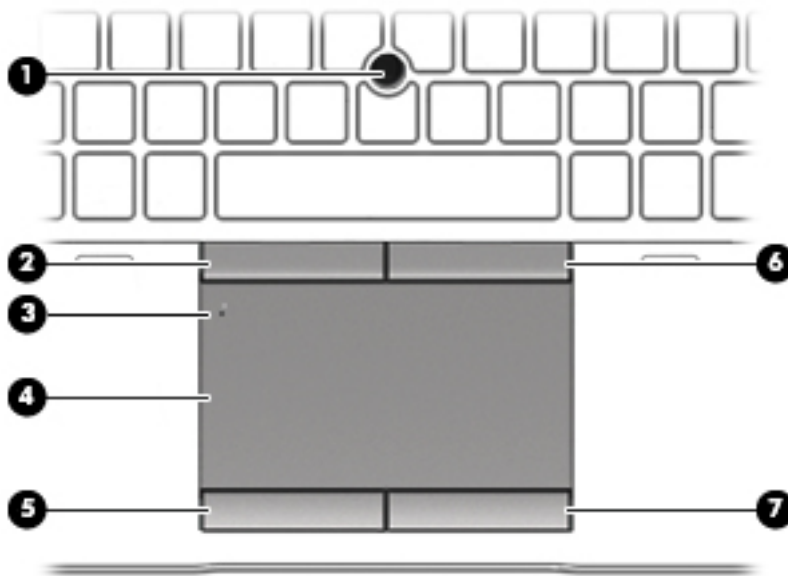



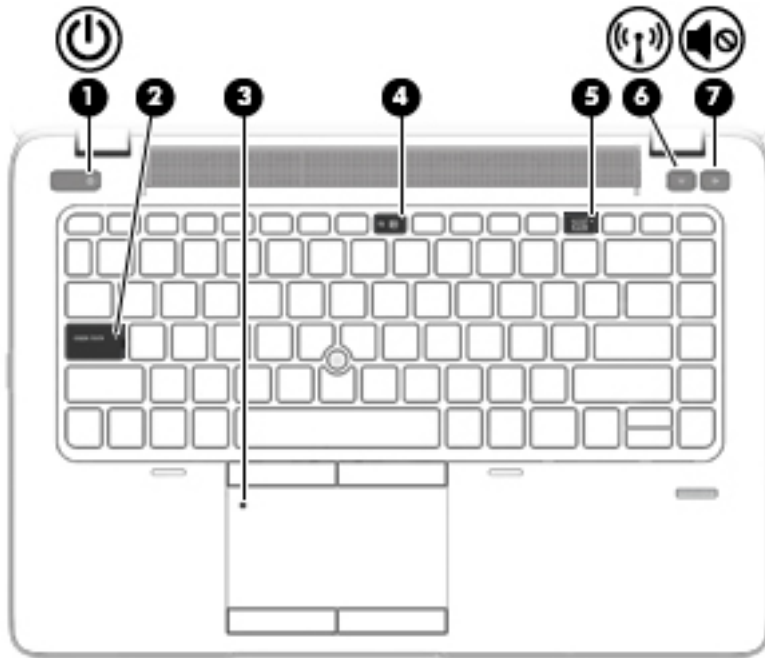

Component	Description
(1) Pointing stick	Moves the pointer and selects or activates items on the screen.
(2) Left pointing stick button	Functions like the left button on an external mouse.
(3) TouchPad on/off button	Turns the TouchPad on and off.
(4) TouchPad zone	Reads your finger gestures to move the pointer or activate items on the screen. NOTE: The TouchPad also supports edge-swipe gestures.
(5) Left TouchPad button	Functions like the left button on an external mouse.
(6) Right pointing stick button	Functions like the right button on an external mouse.
(7) Right TouchPad button	Functions like the right button on an external mouse.

Lights



 **NOTE:** Your computer may look slightly different from the illustration in this section.

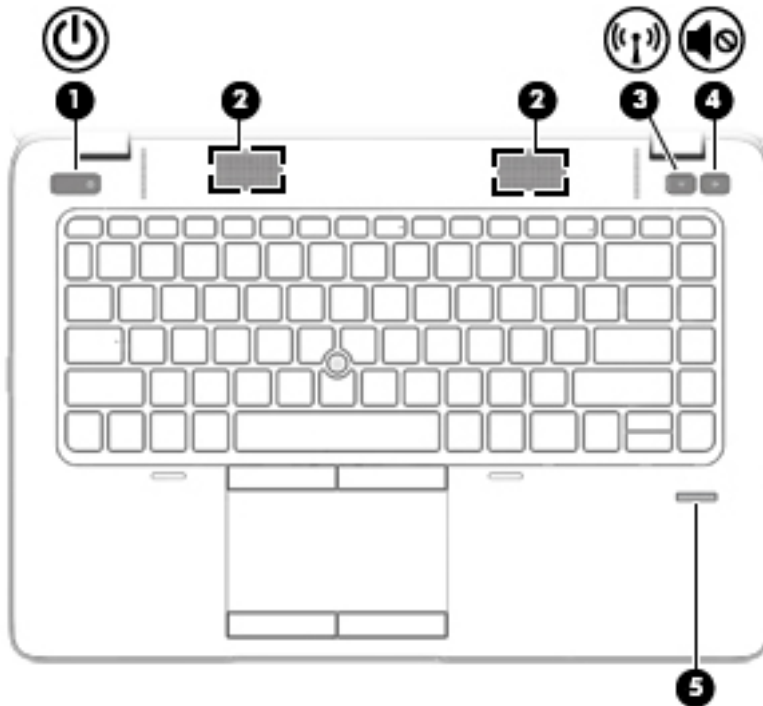

Component	Description
<p>(1)  Power light</p>	<ul style="list-style-type: none"> On: The computer is on. Blinking: The computer is in the Sleep state, a power-saving state. The computer shuts off power to the display and other unneeded components. Off: The computer is off or in Hibernation. Hibernation is a power-saving state that uses the least amount of power. <p>NOTE: For select models, the Intel® Rapid Start Technology feature is enabled at the factory. Rapid Start Technology allows your computer to resume quickly from inactivity.</p>
<p>(2) Caps lock light</p>	<p>On: Caps lock is on, which switches the keys to all capital letters.</p>
<p>(3) TouchPad light</p>	<ul style="list-style-type: none"> On: The TouchPad is off. Off: The TouchPad is on.
<p>(4)  Microphone mute light</p>	<ul style="list-style-type: none"> Amber: microphone sound is off. Off: microphone sound is on.
<p>(5) Num lock light</p>	<p>On: Num lock is on.</p>
<p>(6)  Wireless light</p>	<p>On: An integrated wireless device, such as a wireless local area network (WLAN) device and/or a Bluetooth® device, is on.</p> <p>NOTE: On some models, the wireless light is amber when all wireless devices are off.</p>
<p>(7)  Mute light</p>	<ul style="list-style-type: none"> Amber: Computer sound is off. Off: Computer sound is on.

Buttons, speakers, and fingerprint reader (select models only)





Component	Description
(1)  Power button	<ul style="list-style-type: none"> • When the computer is off, press the button to turn on the computer. • When the computer is on, press the button briefly to initiate Sleep. • When the computer is in the Sleep state, press the button briefly to exit Sleep. • When the computer is in Hibernation, press the button briefly to exit Hibernation. <p>CAUTION: Pressing and holding down the power button will result in the loss of unsaved information.</p> <p>If the computer has stopped responding and Windows® shutdown procedures are ineffective, press and hold the power button for at least 5 seconds to turn off the computer.</p> <p>NOTE: For select models, the Intel® Rapid Start Technology feature is enabled at the factory. Rapid Start Technology allows your computer to resume quickly from inactivity.</p> <p>To learn more about your power settings, see your power options. From the Start screen, type <code>power</code>, select Power and sleep settings, and then select Power and sleep from the list of applications.</p>
(2) Speakers	Produce sound.
(3)  Wireless button	Turns the wireless feature on or off but does not establish a wireless connection.
(4)  Volume mute button	Mutes and restores speaker sound.
(5) Fingerprint reader (select models only)	Allows a fingerprint logon to Windows, instead of a password logon.

Keys

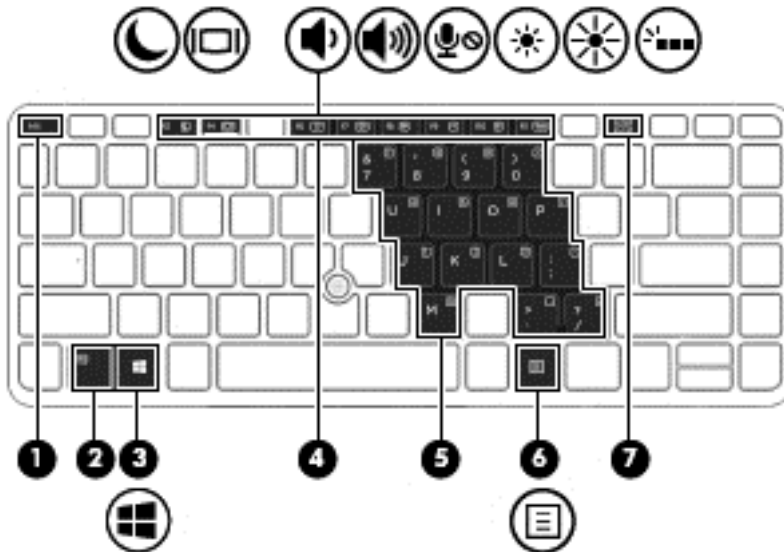

NOTE: Your computer may look slightly different from the illustration in this section.







Component	Description
(1) esc key	Displays system information when pressed in combination with the fn key.
(2) fn key	Executes frequently used system functions when pressed in combination with a function key or the esc key.
(3)  Windows key	Returns you to the Start screen from an open app or the Windows desktop. NOTE: Pressing the Windows key again will return you to the previous screen.
(4) Function keys	Execute frequently used system functions when pressed in combination with the fn key.
(5) Embedded numeric keypad	When the keypad is turned on, it can be used like an external numeric keypad. Each key on the keypad performs the function indicated by the icon in the upper-right corner of the key.
(6)  Windows applications key	Displays options for a selected object.
(7) num lk key	Turns the embedded numeric keypad on and off when pressed in combination with the fn key. Alternates between the navigational and numeric functions on the embedded numeric keypad.

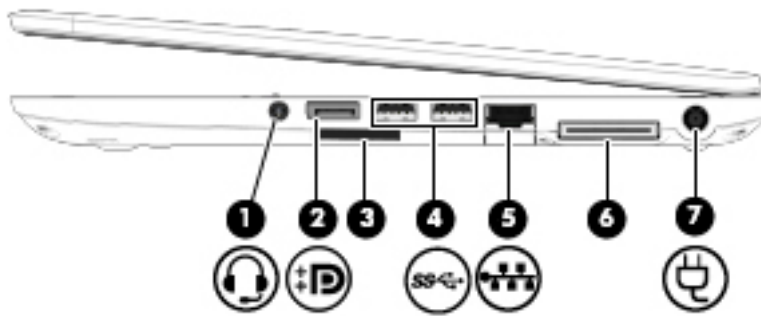



Right

 **NOTE:** Refer to the illustration that most closely matches your computer.

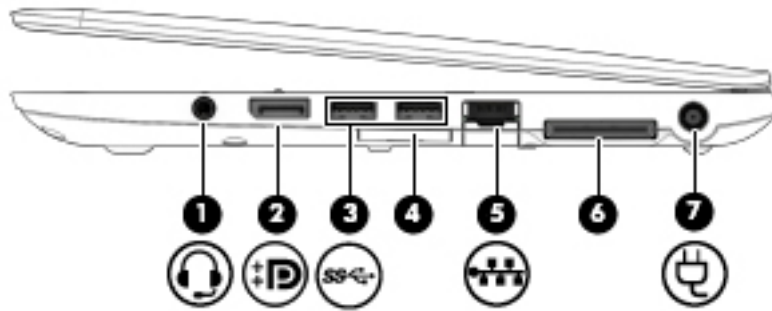

Component	Description
(1)  Audio-out (headphone)/Audio-in (microphone) jack	<p>Connects optional powered stereo speakers, headphones, earbuds, a headset, or a television audio cable. Also connects an optional headset microphone. This jack does not support optional microphone-only devices.</p> <p>WARNING! To reduce the risk of personal injury, adjust the volume before putting on headphones, earbuds, or a headset. For additional safety information, see the <i>Regulatory, Safety, and Environmental Notices</i>. To access this guide, from the Start screen, type <code>support</code>, and then select the HP Support Assistant app.</p> <p>NOTE: When a device is connected to the jack, the computer speakers are disabled.</p> <p>NOTE: Be sure that the device cable has a 4-conductor connector that supports both audio-out (headphone) and audio-in (microphone).</p>
(2)  DisplayPort	Connects an optional digital display device, such as a high-performance monitor or projector.
(3) Memory card reader	Reads optional memory cards that store, manage, share, or access information.
(4)  USB 3.0 port(s)	Connects an optional USB device, such as a keyboard, mouse, external drive, printer, scanner or USB hub.
(5)  RJ-45 (network) jack/lights	<p>Connects a network cable.</p> <ul style="list-style-type: none"> • Green (left): The network is connected. • Amber (right): Activity is occurring on the network.
(6) Docking connector	Connects an optional docking device.
(7)  Power connector	Connects an AC adapter.





Component	Description
(1)  Audio-out (headphone)/Audio-in (microphone) jack	Connects optional powered stereo speakers, headphones, earbuds, a headset, or a television audio cable. Also connects an optional headset microphone. This jack does not support optional microphone-only devices. <p>WARNING! To reduce the risk of personal injury, adjust the volume before putting on headphones, earbuds, or a headset. For additional safety information, see the <i>Regulatory, Safety, and Environmental Notices</i>. To access this guide, from the Start screen, type <code>support</code>, and then select the HP Support Assistant app.</p> <p>NOTE: When a device is connected to the jack, the computer speakers are disabled.</p> <p>NOTE: Be sure that the device cable has a 4-conductor connector that supports both audio-out (headphone) and audio-in (microphone).</p>
(2)  DisplayPort	Connects an optional digital display device, such as a high-performance monitor or projector.
(3)  USB 3.0 ports	Connect optional USB devices, such as a keyboard, mouse, external drive, printer, scanner or USB hub.
(4) Memory card reader	Reads optional memory cards that store, manage, share, or access information.
(5)  RJ-45 (network) jack/lights	Connects a network cable. <ul style="list-style-type: none"> • Green (left): The network is connected. • Amber (right): Activity is occurring on the network.
(6) Docking connector	Connects an optional docking device.
(7)  Power connector	Connects an AC adapter.

Bottom

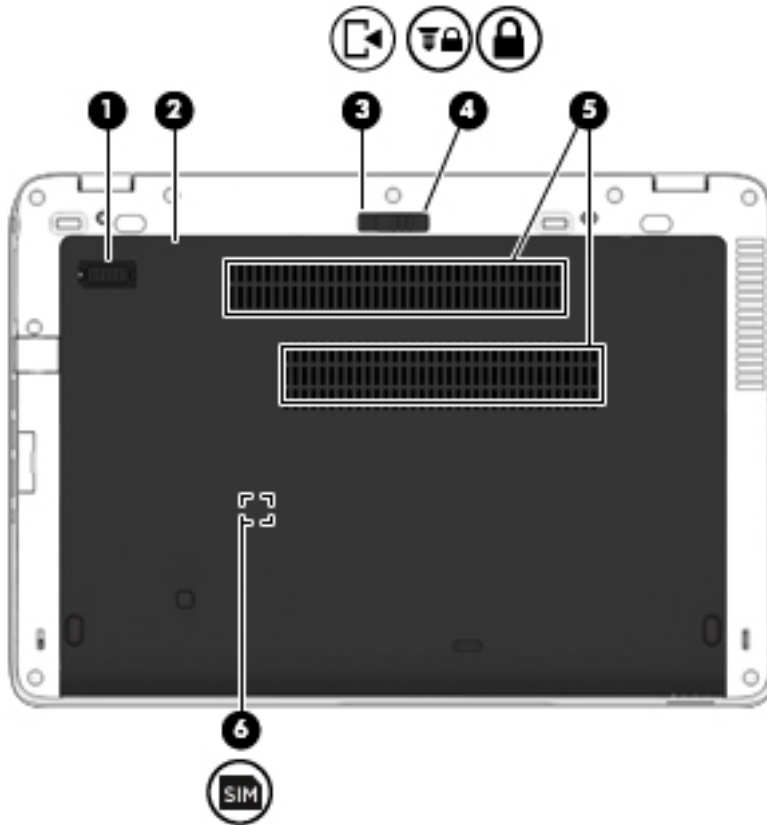
 **NOTE:** Your computer may look slightly different from the illustration in this section.



Component		Description	
(1)	Accessory battery connector (select models only)	Connects an optional accessory battery.	
(2)	Service door	Provides access to the hard drive bay, the wireless LAN (WLAN) module slot, the WWAN module slot, and the memory module slots. CAUTION: To prevent an unresponsive system, replace the wireless module only with a wireless module authorized for use in the computer by the governmental agency that regulates wireless devices in your country or region. If you replace the module and then receive a warning message, remove the module to restore computer functionality, and then contact support through HP Support Assistant. To access HP Support Assistant, from the Start screen, select the HP Support Assistant app.	
(3)		Service door release latch	Releases the service door.
(4)		Service door release lock	Locks the service door.
(5)	Vents (2)	Enable airflow to cool internal components.	

Component	Description
(6) 	SIM slot (select models only) Supports a wireless subscriber identity module (SIM). The SIM slot is located inside the battery bay.

Locating the serial number, product number, and model number

The serial number, product number, and model number of your computer are located on the rear of the computer. You may need the information when you travel internationally or when you contact support.

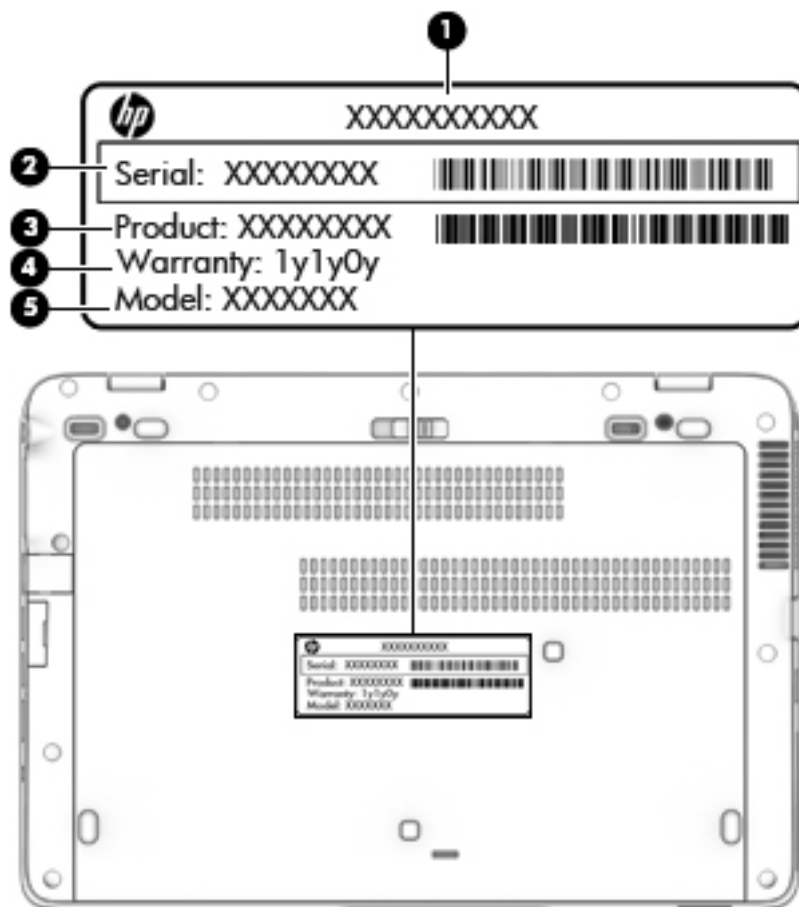

3 Illustrated parts catalog

 **NOTE:** HP continually improves and changes product parts. For complete and current information on supported parts for your computer, go to <http://partsurfer.hp.com>, select your country or region, and then follow the on-screen instructions.

Computer major components

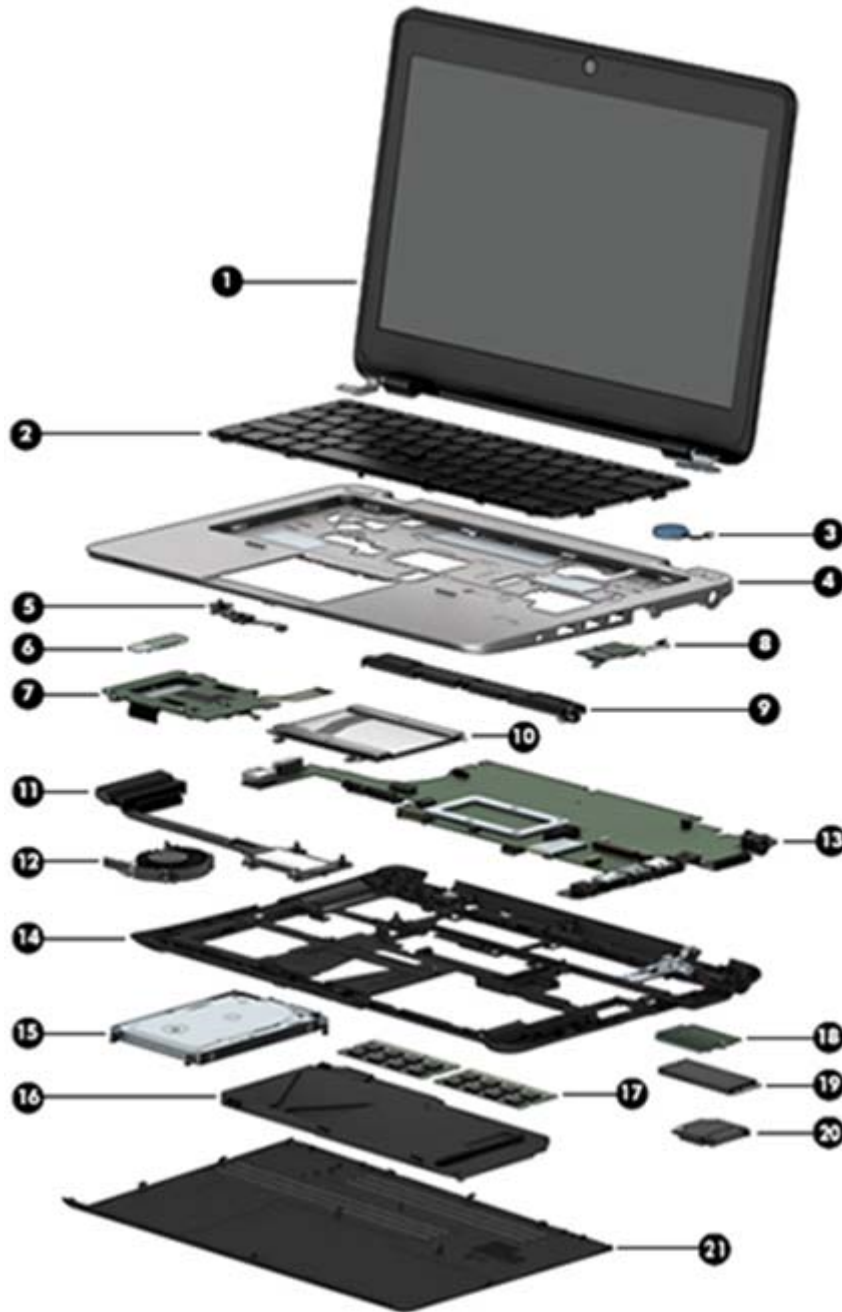

Item	Component	Spare part number
(1)	Display assembly: The TouchScreen display assembly is spared as a whole unit replacement.	
	12.5-in, AntiGlare, FHD, LED, UWVA, TouchScreen display assembly	781838-001
	The non-TouchScreen display assembly is spared at the subcomponent level only. For more display assembly spare part information, see Display assembly components on page 27 .	
(2)	Keyboard with backlight (includes backlight cable and keyboard cable):	
	For use in models with a backlit keyboard:	
	For use in Belgium	776452-A41
	For use in Brazil	776452-201
	For use in Bulgaria	776452-261
	For use in Canada	776452-DB1
	For use in the Czech Republic and Slovakia	776452-FL1
	For use in Denmark	776452-081
	For use in France	776452-051
	For use in Germany	776452-041
	For use in Greece	776452-151
	For use in Hungary	776452-211
	For use in Iceland	776452-DD1
	For use in India	776452-D61
	For use in Israel	776452-BB1
	For use in Italy	776452-061
	For use in Japan	776452-291
	For use in Latin America	776452-161
	For use in the Netherlands	776452-B31
	For use in Northwest Africa	776452-FP1
	For use in Norway	776452-091
	For use in Portugal	776452-131
	For use in Romania	776452-271
	For use in Russia	776452-251
	For use in Saudi Arabia	776452-171
	For use in Slovenia	776452-BA1
	For use in South Korea	776452-AD1
	For use in Spain	776452-071
	For use in Sweden and Finland	776452-B71
	For use in Switzerland	776452-BG1

Item	Component	Spare part number
	For use in Taiwan	776452-AB1
	For use in Thailand	776452-281
	For use in Turkey	776452-141
	For use in the United Kingdom	776452-031
	For use in the United States	776452-001
	Keyboard without backlight (includes keyboard cable):	
	For use in models without a backlit keyboard:	
	For use in Belgium	776451-A41
	For use in Brazil	776451-201
	For use in Bulgaria	776451-261
	For use in Canada	776451-DB1
	For use in the Czech Republic and Slovakia	776451-FL1
	For use in Denmark	776451-081
	For use in France	776451-051
	For use in Germany	776451-041
	For use in Greece	776451-151
	For use in Hungary	776451-211
	For use in Iceland	776451-DD1
	For use in India	776451-D61
	For use in Israel	776451-BB1
	For use in Italy	776451-061
	For use in Japan	776451-291
	For use in Latin America	776451-161
	For use in the Netherlands	776451-B31
	For use in Northwest Africa	776451-FP1
	For use in Norway	776451-091
	For use in Portugal	776451-131
	For use in Romania	776451-271
	For use in Russia	776451-251
	For use in Saudi Arabia	776451-171
	For use in Slovenia	776451-BA1
	For use in South Korea	776451-AD1
	For use in Spain	776451-071
	For use in Sweden and Finland	776451-B71

Item	Component	Spare part number
	For use in Switzerland	776451-BG1
	For use in Taiwan	776451-AB1
	For use in Thailand	776451-281
	For use in Turkey	776451-141
	For use in the United Kingdom	776451-031
	For use in the United States	776451-001
(3)	RTC battery (includes cable and double-sided adhesive)	702853-001
(4)	Top cover	783215-001
(5)	Power button board (includes cable)	730552-001
(6)	NFC module	781862-001
(7)	Card reader board (includes cable)	781841-001
(8)	Fingerprint reader board (includes bracket and cable)	730554-001
(9)	Speaker assembly (includes left and right speakers and cables)	730555-001
(10)	TouchPad (includes cable)	
	For use in models without NFC	781859-001
	For use in models with NFC; includes NFC antenna	781860-001
(11)	Heat sink (includes replacement thermal material):	730556-001
(12)	Fan (includes cable):	730547-001
(13)	System board , equipped with: (includes a graphics subsystem with UMA memory and replacement thermal material)	
	Intel Core i7-5600U processor and the Windows 8 Professional operating system	781858-601
	Intel Core i7-5600U processor and the Windows 8 Standard operating system	781858-501
	Intel Core i7-5600U processor and a non-Windows 8 operating system	781858-001
	Intel Core i7-5500U processor and the Windows 8 Professional operating system	781857-601
	Intel Core i7-5500U processor and the Windows 8 Professional operating system	781857-501
	Intel Core i7-5500U processor and a non-Windows 8 operating system	781857-001
	Intel Core i5-5300U processor and the Windows 8 Professional operating system	781856-601
	Intel Core i5-5300U processor and the Windows 8 Standard operating system	781856-501
	Intel Core i5-5300U processor and a non-Windows 8 operating system	781856-001
	Intel Core i5-5200U processor and the Windows 8 Professional operating system	781855-601
	Intel Core i5-5200U processor and the Windows 8 Standard operating system	781855-501
	Intel Core i5-5200U processor and a non-Windows 8 operating system	781855-001
	Intel Core i3-5010U processor and the Windows 8 Professional operating system	781854-601
	Intel Core i3-5010U processor and the Windows 8 Standard operating system	781854-501

Item	Component	Spare part number
	Intel Core i3-5010U processor and a non-Windows 8 operating system	781854-001
(14)	Base enclosure (includes RJ-45 cover, rubber feet, and service cover eject latch assembly):	765603-001
	Rubber Kit (not illustrated, includes base enclosure rubber screw covers)	730550-001
(15)	Hard drive (does not include hard drive bracket, hard drive connector adapter, or screws):	
	NOTE: The hard drive bracket, hard drive connector adapter, and screws are included in the Hard Drive Hardware Kit, spare part number 730539-001.	
	1-TB, 5400-rpm, SATA, 7.0-mm hard drive	762990-001
	500-GB, 7200-rpm, SATA, 7.0-mm hard drive	703267-001
	500-GB, 7200-rpm, SED, 7.0-mm hard drive	703268-001
	500-GB, 5400-rpm, SATA, FIPS, 7.0-mm hard drive	730946-001
	320-GB, 7200-rpm, SATA, 7.0-mm hard drive	778184-001
(16)	Battery:	
	3-cell, 46-WHr, 4.15-AHr, Li-ion battery	717378-001
	3-cell, 26-WHr, 2.50-AHr, Li-ion battery	717377-001
(17)	Memory module (PCL3, 12800, 1600-MHz):	
	8 GB	693374-001
	4 GB	691740-001
(18)	WWAN module:	
	HP hs3110 HSPA+ Mobile Broadband Module	793516-001
	HP lt4112 LTE/HPSA+ Mobile Broadband Module	790198-001
	HP lt4211 LTE/EV-DO/HSPA+ Mobile Broadband Module	793116-001
(19)	Solid-state drive:	
	NOTE: M.2 drive shown	
	512-GB, SATA-3, solid-state drive	781850-001
	256-GB, SATA-3, SED, Opal 2, solid-state drive	781849-001
	256-GB, SATA-3, SATA-3, TLC, solid-state drive	798956-001
	256-GB, M.2, PCIe, solid-state drive	781853-001
	240-GB, SATA-3, solid-state drive	781847-001
	180-GB, SATA-3, SED, Opal 2, solid-state drive	781846-001
	180-GB, SATA-3, solid-state drive	781843-001
	128-GB, SATA-3, TLC, solid-state drive	798955-001
	128-GB, SATA-3, solid-state drive	781842-001
	120-GB, SATA-3, M.2, solid-state drive	781852-001
	32-GB, SATA-3, M.2, solid-state drive	781851-001
(20)	WLAN module:	

Item	Component	Spare part number
	Intel Dual Band Wireless-AC 7265AN 802.11 a/b/g/n 2×2 WiFi + Bluetooth 4.0 WLAN module	756748-001
	Intel Dual Band Wireless-N 7265 802.11 a/c 2×2 WiFi + Bluetooth 4.0 Combo Adapter	756749-001
	Intel Dual Band Wireless-N 7265 802.11 a/c 2×2 WiFi + Bluetooth 4.0 Combo Adapter for use in Indonesia	783721-001
	Intel Dual Band Wireless-AC 3160 802.11 a/b/g/n+a/c 2×2 WiFi Adapter	784644-001
(21)	Service cover (includes rubber feet):	
	For use in 820 G2 models	781836-001
	For use in 720 G2 models	790080-001
	For use only on RCTO models	797517-001

Display assembly components

 **NOTE:** The display assembly components listed in this section are for use only on computer models equipped with a non-TouchScreen display assembly.

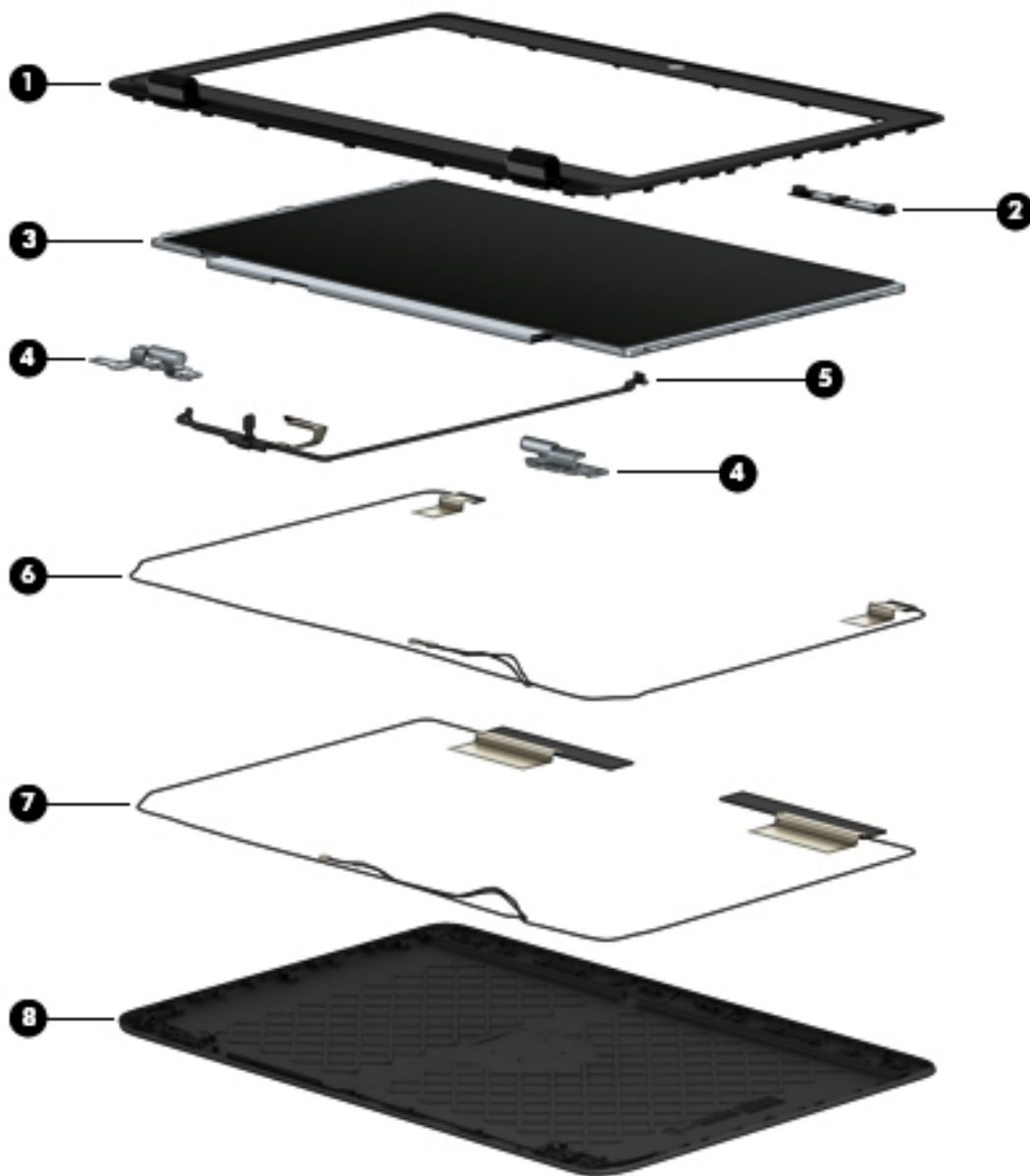

Item	Component	Spare part number
(1)	Display bezel:	
	For use on 720 G2 models with an HD display panel	786930-001
	For use on 720 G2 models with an FHD display panel	790381-001
	For use on 820 G2 models with an HD display panel	730544-001
	For use on 820 G2 models with an FHD display panel	781837-001
(2)	Webcam/microphone module (includes double-sided adhesive):	781861-001

Item	Component	Spare part number
	Microphone module (includes double-sided adhesive)	730795-001
(3)	Display panel:	
	12.5-in, AG, FHD, LED, UWVA display panel	781864-001
	12.5-in, AG, HD, LED, SVA display panel	781863-001
(4)	Display Hinge Kit (includes left and right display hinges):	
	For use only on computer models equipped with an FHD display	775895-001
	For use only on computer models equipped with an HD display	730543-001
(5)	Display Cable Kit (includes display panel cable and webcam/microphone module cable)	730537-001
	Antenna Kit , includes:	
(6)	WLAN antenna cables and transceivers	
(7)	WWAN antenna cables and transceivers	
	For use only on computer models equipped with an HD display	781834-001
	For use only on computer models equipped with an FHD display	781835-001
(8)	Display enclosure:	
	For use only on computer models equipped with an FHD display	775893-001
	For use only on computer models equipped with an HD display	730561-001
	Display Panel Support Kit (not illustrated, includes display enclosure, WLAN antenna cables and transceivers, and WWAN antenna cables and transceivers):	
	For use only on computer models equipped with an HD display	781839-001
	For use only on computer models equipped with an FHD display	781840-001

Plastics Kit



Item	Component	Spare part number
	Plastics Kit, includes:	730562-001
(1)	Card reader bezel	
(2)	Display cable connector bracket	
(3)	Fingerprint reader cover	
(4)	RJ-45 cover	
(5a)	Service cover release latch actuator	
(5b)	Service cover release latch arm	
	Service cover release latch spring (not illustrated)	

Mass storage devices



Item	Component	Spare part number
(1)	Hard drive (does not include hard drive bracket, hard drive connector adapter, or screws):	
	NOTE: The hard drive bracket, hard drive connector adapter, and screws are included in the Hard Drive Hardware Kit.	
	512-GB, SATA-3, solid-state drive	781850-001
	256-GB, SATA-3, SED, Opal 2, solid-state drive	781849-001
	256-GB, SATA-3, TLC, solid-state drive	798956-001
	256-GB, M.2, PCIe, solid-state drive	781853-001
	240-GB, SATA-3, solid-state drive	781847-001
	180-GB, SATA-3, SED, Opal 2, solid-state drive	781846-001
	180-GB, SATA-3, solid-state drive	781843-001
	128-GB, SATA-3, TLC, solid-state drive	798955-001
	128-GB, SATA-3, solid-state drive	781842-001
	120-GB, SATA-3, M.2 solid-state drive	781852-001
	32-GB, SATA-3, M.2, solid-state drive	781851-001

Miscellaneous parts

Component	Spare part number
AC adapter:	
65-W HP Smart adapter (EM, RC/V, 3-wire, 4.5-mm)	693710-001
65-W HP Smart adapter (non-PFC, 3-wire, 4.5-mm)	693711-001
45-W HP Smart adapter (non-PFC, RC, 7.4-mm)	744893-001
45-W HP Smart adapter (non-PFC, RC, 3-wire, 4.5-mm)	721092-001
45-W HP Smart adapter (non-PFC, RC, 2-wire, 4.5-mm)	742437-001
65-W, 3-pin to standard connector (converts 3-pin Smart power connector to standard/legacy power connector)	414135-001
Smart AC adapter dongle , 7.4mm	734734-001
HP DisplayPort-to-HDMI 1.4 adapter	749288-001
Carrying case:	
HP Essential top-load carrying case	679921-001
HP business top-load carrying case	718550-001
HP 2013 UltraSlim Docking Station	732252-001
HP Mobile Connect SIM module	714749-001
Lock:	
HP docking station cable lock	575921-001
HP ultraslim keyed cable lock	703372-001
Mouse:	
HP comfort-grip wireless mouse	691922-001
HP USB laser mouse	674318-001
HP USB travel mouse	757770-001
Power cord (3-pin, black, 1.83-m):	
For use in Argentina	490371-D01
For use in Australia	490371-011
For use in Brazil	490371-202
For use in Denmark	490371-081
For use in Europe	490371-021
For use in India	490371-D61
For use in Israel	490371-BB1
For use in Italy	490371-061
For use in Japan	490371-291
For use in North America	490371-001

Component	Spare part number
For use in the People's Republic of China	490371-AA1
For use in South Africa	490371-AR1
For use in South Korea	490371-AD1
For use in Switzerland	490371-111
For use in Taiwan	490371-AB1
For use in Thailand	490371-201
For use in the United Kingdom and Singapore	490371-031
Power cord (3-pin, black, 1.00-m):	
For use in Argentina	755530-D01
For use in Australia	755530-011
For use in Brazil	755530-202
For use in Denmark	755530-081
For use in Europe	755530-021
For use in India	755530-D61
For use in Israel	755530-BB1
For use in Italy	755530-061
For use in Japan	755530-291
For use in North America	755530-001
For use in the People's Republic of China	755530-AA1
For use in South Africa	755530-AR1
For use in South Korea	755530-AD1
For use in Switzerland	755530-111
For use in Taiwan	755530-AB1
For use in Thailand	755530-201
For use in the United Kingdom and Singapore	755530-031
Power cord for use in Japan (2-pin, black, 1.00-m):	762689-291
Screw Kit	730553-001

Sequential part number listing

CSR flag designations:

A = Mandatory

B = Optional

C = Service technician recommended

N = Non-user replaceable

Spare part number	CSR flag	Description
414135-001	A	65-W 3 pin to standard connector
490371-001	A	Power cord for use in North America (3-pin, black, 1.83-m)
490371-011	A	Power cord for use in Australia (3-pin, black, 1.83-m)
490371-021	A	Power cord for use in Europe (3-pin, black, 1.83-m)
490371-031	A	Power cord for use in the United Kingdom and Singapore (3-pin, black, 1.83-m)
490371-061	A	Power cord for use in Italy (3-pin, black, 1.83-m)
490371-081	A	Power cord for use in Denmark (3-pin, black, 1.83-m)
490371-111	A	Power cord for use in Australia (3-pin, black, 1.83-m)
490371-201	A	Power cord for use in Thailand (3-pin, black, 1.83-m)
490371-202	A	Power cord for use in Brazil (3-pin, black, 1.83-m)
490371-291	A	Power cord for use in Japan (3-pin, black, 1.83-m)
490371-AA1	A	Power cord for use in the People's Republic of China (3-pin, black, 1.83-m)
490371-AB1	A	Power cord for use in Taiwan (3-pin, black, 1.83-m)
490371-AD1	A	Power cord for use in South Korea (3-pin, black, 1.83-m)
490371-AR1	A	Power cord for use in South Africa (3-pin, black, 1.83-m)
490371-BB1	A	Power cord for use in Israel (3-pin, black, 1.83-m)
490371-D01	A	Power cord for use in Argentina (3-pin, black, 1.83-m)
490371-D61	A	Power cord for use in India (3-pin, black, 1.83-m)
575921-001	A	HP docking station cable lock
674318-001	A	HP USB laser mouse
679921-001	A	HP Essential top-load carrying case
691740-001	A	4-GB memory module (PCL3, 12800, 1600-MHz)
691922-001	A	HP comfort-grip wireless mouse
693374-001	A	4-GB memory module (PCL3, 12800, 1600-MHz)
693710-001	A	65-W HP Smart adapter (EM, RC/V, 3-wire, 4.5-mm)
693711-001	A	65-W HP Smart adapter (non-PFC, 3-wire, 4.5-mm)
702853-001	B	RTC battery (includes cable and double-sided adhesive)

Spare part number	CSR flag	Description
703267-001	A	500-GB, 7200-rpm, SATA, 7.0-mm hard drive for use on all computer models (does not include hard drive bracket, hard drive connector adapter, or screws) NOTE: The hard drive bracket, hard drive connector adapter, and screws are included in the Hard Drive Hardware Kit, spare part number 730539-001.
703268-001	A	500-GB, 7200-rpm, SED, 7.0-mm hard drive for use on all computer models (does not include hard drive bracket, hard drive connector adapter, or screws) NOTE: The hard drive bracket, hard drive connector adapter, and screws are included in the Hard Drive Hardware Kit, spare part number 730539-001.
703372-001	A	HP ultraslim keyed cable lock
714749-001	A	HP Mobile Connect SIM module
717377-001	A	3-cell, 26-WHr, 2.50-AHr, Li-ion battery
717378-001	A	3-cell, 46-WHr, 4.15-AHr, Li-ion battery
718550-001	A	HP business top-load carrying case
721092-001	N	45-W HP Smart adapter (non-PFC, RC, 3-wire, 4.5-mm)
730537-001	N	Display Cable Kit (includes display panel cable and webcam/microphone module cable)
730539-001	N	Hard Drive Hardware Kit (includes hard drive bracket, hard drive connector adapter, and screws)
730543-001	N	Display Hinge Kit for use only on computer models equipped with an HD display (includes left and right hinges and hinge brackets)
730544-001	N	Display bezel for use on 820 G2 models with an HD display panel
730547-001	N	Fan (includes cable)
730550-001	A	Rubber Kit (includes base enclosure rubber screw covers)
730552-001	N	Power button board (includes cable)
730553-001	N	Screw Kit
730554-001	N	Fingerprint reader board (includes bracket and cable)
730555-001	N	Speaker assembly (includes left and right speakers and cables)
730556-001	N	Heat sink (includes replacement thermal material)
730561-001	N	Display enclosure for use only on computer models equipped with an HD display
730562-001	N	Plastics Kit
730795-001	N	Microphone module
730946-001	A	500-GB, 5400-rpm, SATA, FIPS 7.0-mm hard drive for use on all computer models (does not include hard drive bracket, hard drive connector adapter, or screws) NOTE: The hard drive bracket, hard drive connector adapter, and screws are included in the Hard Drive Hardware Kit, spare part number 730539-001.
732252-001	A	HP 2013 UltraSlim Docking Station
734734-001	A	Smart AC adapter dongle, 7.4mm
742437-001	A	45-W HP Smart adapter (non-PFC, RC, 2-wire, 4.5-mm)
744893-001	A	45-W HP Smart adapter (non-PFC, RC, 7.4-mm)
749288-001	A	HP DisplayPort-to-HDMI 1.4 adapter

Spare part number	CSR flag	Description
755530-001	A	Power cord for use in North America (3-pin, black, 1.00-m)
755530-011	A	Power cord for use in Australia (3-pin, black, 1.00-m)
755530-021	A	Power cord for use in Europe (3-pin, black, 1.00-m)
755530-031	A	Power cord for use in the United Kingdom and Singapore (3-pin, black, 1.00-m)
755530-061	A	Power cord for use in Italy (3-pin, black, 1.00-m)
755530-081	A	Power cord for use in Denmark (3-pin, black, 1.00-m)
755530-111	A	Power cord for use in Switzerland (3-pin, black, 1.00-m)
755530-201	A	Power cord for use in Thailand (3-pin, black, 1.00-m)
755530-202	A	Power cord for use in Brazil (3-pin, black, 1.00-m)
755530-291	A	Power cord for use in Japan (3-pin, black, 1.00-m)
755530-AA1	A	Power cord for use in the People's Republic of China (3-pin, black, 1.00-m)
755530-AB1	A	Power cord for use in Taiwan (3-pin, black, 1.00-m)
755530-AD1	A	Power cord for use in South Korea (3-pin, black, 1.00-m)
755530-AR1	A	Power cord for use in South Africa (3-pin, black, 1.00-m)
755530-BB1	A	Power cord for use in Israel (3-pin, black, 1.00-m)
755530-D01	A	Power cord for use in Argentina (3-pin, black, 1.00-m)
755530-D61	A	Power cord for use in India (3-pin, black, 1.00-m)
756748-001	A	Intel Dual Band Wireless-AC 7265AN 802.11 a/b/g/n 2x2 WiFi + Bluetooth 4.0 WLAN module
756749-001	A	Intel Dual Band Wireless-N 7265 802.11 a/c 2x2 WiFi + Bluetooth 4.0 Combo Adapter
757770-001	A	HP USB travel mouse
762689-291	A	Power cord for use in Japan (2-pin, black, 1.00-m)
762990-001	A	1-TB, 5400-rpm, 7.0-mm hard drive for use only on computer models equipped with an AMD processor (does not include hard drive bracket, hard drive connector adapter, or screws) NOTE: The hard drive bracket, hard drive connector adapter, and screws are included in the Hard Drive Hardware Kit, spare part number 730539-001.
765603-001	A	Base enclosure (includes RJ-45 cover, rubber feet, and service cover eject latch assembly)
775893-001	N	Display enclosure for use only on computer models equipped with an FHD display
775895-001	N	Display Hinge Kit for use only on computer models equipped with an FHD display (includes left and right hinges and hinge brackets)
776451-001	B	Keyboard (no backlight) with pointing stick for use only on computer models in the United States (includes keyboard cable)
776451-031	B	Keyboard (no backlight) with pointing stick for use only on computer models in the United Kingdom (includes keyboard cable)
776451-041	B	Keyboard (no backlight) with pointing stick for use only on computer models in Germany (includes keyboard cable)
776451-051	B	Keyboard (no backlight) with pointing stick for use only on computer models in France (includes keyboard cable)

Spare part number	CSR flag	Description
776451-061	B	Keyboard (no backlight) with pointing stick for use only on computer models in Italy (includes keyboard cable)
776451-071	B	Keyboard (no backlight) with pointing stick for use only on computer models in Spain (includes keyboard cable)
776451-081	B	Keyboard (no backlight) with pointing stick for use only on computer models in Denmark (includes keyboard cable)
776451-091	B	Keyboard (no backlight) with pointing stick for use only on computer models in Norway (includes keyboard cable)
776451-131	B	Keyboard (no backlight) with pointing stick for use only on computer models in Portugal (includes keyboard cable)
776451-141	B	Keyboard (no backlight) with pointing stick for use only on computer models in Turkey (includes keyboard cable)
776451-151	B	Keyboard (no backlight) with pointing stick for use only on computer models in Greece (includes keyboard cable)
776451-161	B	Keyboard (no backlight) with pointing stick for use only on computer models in Latin America (includes keyboard cable)
776451-171	B	Keyboard (no backlight) with pointing stick for use only on computer models equipped in Saudi Arabia (includes keyboard cable)
776451-201	B	Keyboard (no backlight) with pointing stick for use only on computer models in Brazil (includes keyboard cable)
776451-211	B	Keyboard (no backlight) with pointing stick for use only on computer models in Hungary (includes keyboard cable)
776451-251	B	Keyboard (no backlight) with pointing stick for use only on computer models in Russia (includes keyboard cable)
776451-261	B	Keyboard (no backlight) with pointing stick for use only on computer models in Bulgaria (includes keyboard cable)
776451-271	B	Keyboard (no backlight) with pointing stick for use only on computer models in Romania (includes keyboard cable)
776451-281	B	Keyboard (no backlight) with pointing stick for use only on computer models in Thailand (includes keyboard cable)
776451-291	B	Keyboard (no backlight) with pointing stick for use only on computer models in Japan (includes keyboard cable)
776451-A41	B	Keyboard (no backlight) with pointing stick for use only on computer models in Belgium (includes keyboard cable)
776451-AB1	B	Keyboard (no backlight) with pointing stick for use only on computer models in Taiwan (includes keyboard cable)
776451-AD1	B	Keyboard (no backlight) with pointing stick for use only on computer models in South Korea (includes keyboard cable)
776451-B31	B	Keyboard (no backlight) with pointing stick for use only on computer models in the Netherlands (includes keyboard cable)
776451-B71	B	Keyboard (no backlight) with pointing stick for use only on computer models in Sweden and Finland (includes keyboard cable)
776451-BA1	B	Keyboard (no backlight) with pointing stick for use only on computer models in Slovenia (includes keyboard cable)

Spare part number	CSR flag	Description
776451-BB1	B	Keyboard (no backlight) with pointing stick for use only on computer models in Israel (includes keyboard cable)
776451-BG1	B	Keyboard (no backlight) with pointing stick for use only on computer models in Switzerland (includes keyboard cable)
776451-D61	B	Keyboard (no backlight) with pointing stick for use only on computer models in India (includes keyboard cable)
776451-DB1	B	Keyboard (no backlight) with pointing stick for use only on computer models in Canada (includes keyboard cable)
776451-DD1	B	Keyboard (no backlight) with pointing stick for use only on computer models in Iceland (includes keyboard cable)
776451-FL1	B	Keyboard (no backlight) with pointing stick for use only on computer models in the Czech Republic and Slovakia (includes keyboard cable)
776451-FP1	B	Keyboard (no backlight) with pointing stick for use only on computer models in Northwest Africa (includes keyboard cable)
776452-001	B	Keyboard with backlight and pointing stick for use only on computer models in the United States (includes backlight cable and keyboard cable)
776452-031	B	Keyboard with backlight and pointing stick for use only on computer models in the United Kingdom (includes backlight cable and keyboard cable)
776452-041	B	Keyboard with backlight and pointing stick for use only on computer models in Germany (includes backlight cable and keyboard cable)
776452-051	B	Keyboard with backlight and pointing stick for use only on computer models in France (includes backlight cable and keyboard cable)
776452-061	B	Keyboard with backlight and pointing stick for use only on computer models in Italy (includes backlight cable and keyboard cable)
776452-071	B	Keyboard with backlight and pointing stick for use only on computer models in Spain (includes backlight cable and keyboard cable)
776452-081	B	Keyboard with backlight and pointing stick for use only on computer models in Denmark (includes backlight cable and keyboard cable)
776452-091	B	Keyboard with backlight and pointing stick for use only on computer models in Norway (includes backlight cable and keyboard cable)
776452-131	B	Keyboard with backlight and pointing stick for use only on computer models in Portugal (includes backlight cable and keyboard cable)
776452-141	B	Keyboard with backlight and pointing stick for use only on computer models in Turkey (includes backlight cable and keyboard cable)
776452-151	B	Keyboard with backlight and pointing stick for use only on computer models in Greece (includes backlight cable and keyboard cable)
776452-161	B	Keyboard with backlight and pointing stick for use only on computer models in Latin America (includes backlight cable and keyboard cable)
776452-171	B	Keyboard with backlight and pointing stick for use only on computer models in Saudi Arabia (includes backlight cable and keyboard cable)
776452-201	B	Keyboard with backlight and pointing stick for use only on computer models in Brazil (includes backlight cable and keyboard cable)
776452-211	B	Keyboard with backlight and pointing stick for use only on computer models in Hungary (includes backlight cable and keyboard cable)

Spare part number	CSR flag	Description
776452-251	B	Keyboard with backlight and pointing stick for use only on computer models in Russia (includes backlight cable and keyboard cable)
776452-261	B	Keyboard with backlight and pointing stick for use only on computer models in Bulgaria (includes backlight cable and keyboard cable)
776452-271	B	Keyboard with backlight and pointing stick for use only on computer models in Romania (includes backlight cable and keyboard cable)
776452-281	B	Keyboard with backlight and pointing stick for use only on computer models in Thailand (includes backlight cable and keyboard cable)
776452-291	B	Keyboard with backlight and pointing stick for use only on computer models in Japan (includes backlight cable and keyboard cable)
776452-A41	B	Keyboard with backlight and pointing stick for use only on computer models in Belgium (includes backlight cable and keyboard cable)
776452-AB1	B	Keyboard with backlight and pointing stick for use only on computer models in Taiwan (includes backlight cable and keyboard cable)
776452-AD1	B	Keyboard with backlight and pointing stick for use only on computer models in South Korea (includes backlight cable and keyboard cable)
776452-B31	B	Keyboard with backlight and pointing stick for use only on computer models in the Netherlands (includes backlight cable and keyboard cable)
776452-B71	B	Keyboard with backlight and pointing stick for use only on computer models in Sweden and Finland (includes backlight cable and keyboard cable)
776452-BA1	B	Keyboard with backlight and pointing stick for use only on computer models in Slovenia (includes backlight cable and keyboard cable)
776452-BB1	B	Keyboard with backlight and pointing stick for use only on computer models in Israel (includes backlight cable and keyboard cable)
776452-BG1	B	Keyboard with backlight and pointing stick for use only on computer models in Switzerland (includes backlight cable and keyboard cable)
776452-D61	B	Keyboard with backlight and pointing stick for use only on computer models in India (includes backlight cable and keyboard cable)
776452-DB1	B	Keyboard with backlight and pointing stick for use only on computer models in Canada (includes backlight cable and keyboard cable)
776452-DD1	B	Keyboard with backlight and pointing stick for use only on computer models in Iceland (includes backlight cable and keyboard cable)
776452-FL1	B	Keyboard with backlight and pointing stick for use only on computer models in the Czech Republic and Slovakia (includes backlight cable and keyboard cable)
776452-FP1	B	Keyboard with backlight and pointing stick for use only on computer models in the Northwest Africa (includes backlight cable and keyboard cable)
778184-001	A	320-GB, 7200-rpm, SATA, 7.0-mm hard drive for use on all computer models (does not include hard drive bracket, hard drive connector adapter, or screws) NOTE: The hard drive bracket, hard drive connector adapter, and screws are included in the Hard Drive Hardware Kit, spare part number 730539-001.
781834-001	N	Antenna Kit for use only on computer models equipped with an HD display (WLAN antenna cables and transceivers and WWAN antenna cables and transceivers)
781835-001	N	Antenna Kit for use only on computer models equipped with an FHD display (includes WLAN antenna cables and transceivers and WWAN antenna cables and transceivers)

Spare part number	CSR flag	Description
781836-001	A	Service cover for use in 820 G2 models (includes rubber feet)
781837-001	N	Display bezel for use on 820 G2 models with an HD display panel
781838-001	N	12.5-in, AG, FHD, LED, UWVA, TouchScreen display assembly
781839-001	N	Display Panel Support Kit for use only on computer models equipped with an HD display (includes display enclosure, WLAN antenna cables and transceivers, and WWAN antenna cables and transceivers)
781840-001	N	Display Panel Support Kit for use only on computer models equipped with an FHD display(includes display enclosure, WLAN antenna cables and transceivers, and WWAN antenna cables and transceivers)
781841-001	N	Card reader board (includes cable)
781842-001	A	128-GB, SATA-3, solid-state drives
781843-001	A	180-GB, SATA-3 solid-state drive for use only on computer models equipped with an Intel processor
781846-001	A	180-GB, SATA-3, SED, Opal 2, solid-state drive
781847-001	A	240-GB, SATA-3 solid-state drive for use only on computer models equipped with an Intel processor
781849-001	A	256-GB, SATA-3, SED, Opal 2, solid-state drive for use only on computer models equipped with an Intel processor
781850-001	A	512-GB, SATA-3 solid-state drive for use only on computer models equipped with an Intel processor
781851-001	A	32-GB, SATA-3, M.2, solid-state drive
781852-001	A	120-GB, SATA-3, M.2, solid-state drive
781853-001	A	256-GB, M.2, PCIe, solid-state drive
781854-001	N	System board equipped with an Intel Core i3-5010U processor and a non-Windows 8 operating system (includes replacement thermal material)
781854-501	N	System board equipped with an Intel Core i3-5010U processor and the Windows 8 Standard operating system (includes replacement thermal material)
781854-601	N	System board equipped with an Intel Core i3-5010U processor and the Windows 8 Professional operating system (includes replacement thermal material)
781855-001	N	System board equipped with an Intel Core i5-5200U processor and a non-Windows 8 operating system (includes replacement thermal material)
781855-501	N	System board equipped with an Intel Core i5-5200U processor and the Windows 8 Standard operating system (includes replacement thermal material)
781855-601	N	System board equipped with an Intel Core i5-5200U processor and the Windows 8 Professional operating system (includes replacement thermal material)
781856-001	N	System board equipped with an Intel Core i5-5300U processor and a non-Windows 8 operating system (includes replacement thermal material)
781856-501	N	System board equipped with an Intel Core i5-5300U processor and the Windows 8 Standard operating system (includes replacement thermal material)
781856-601	N	System board equipped with an Intel Core i5-5300U processor and the Windows 8 Professional operating system (includes replacement thermal material)

Spare part number	CSR flag	Description
781857-001	N	System board equipped with an Intel Core i7-5500U processor and a non-Windows 8 operating system (includes replacement thermal material)
781857-501	N	System board equipped with an Intel Core i7-5500U processor and the Windows 8 Standard operating system (includes replacement thermal material)
781857-601	N	System board equipped with an Intel Core i7-5500U processor and the Windows 8 Professional operating system (includes replacement thermal material)
781858-001	N	System board equipped with an Intel Core i7-5600U processor and a non-Windows 8 operating system (includes replacement thermal material)
781858-501	N	System board equipped with an Intel Core i7-5600U processor and the Windows 8 Standard operating system (includes replacement thermal material)
781858-601	N	System board equipped with an Intel Core i7-5600U processor and the Windows 8 Professional operating system (includes replacement thermal material)
781859-001	N	TouchPad for use in models without NFC (includes cable)
781860-001	N	TouchPad for use in models with NFC; includes NFC antenna and TouchPad cable
781861-001	N	Webcam/microphone module (includes double-sided adhesive)
781862-001	N	NFC module
781863-001	N	12.5-in, AG, FHD, LED, SVA non-TouchScreen display panel
781864-001	N	12.5-in, AG, FHD, LED, SVA TouchScreen display panel
783215-001	N	Top cover
783721-001	A	Intel Dual Band Wireless-N 7265 802.11 a/c 2x2 WiFi + Bluetooth 4.0 Combo Adapter for use in Indonesia
784644-001	A	Intel Dual Band Wireless-AC 3160 802.11 a/b/g/n+a/c 2x2 WiFi Adapter
786930-001	N	Display bezel for use on 720 G2 models with an HD display panel
790080-001	A	Service cover for use in 720 G2 models (includes rubber feet)
790198-001	A	HP It4112 LTE/HSPA+ Mobile Broadband Module
790381-001	N	Display bezel for use on 720 G2 models with an FHD display panel
793116-001	A	HP It4211 LTE/EV-DO/HSPA+ Mobile Broadband Module
793516-001	A	HP hs3110 HSPA+ Mobile Broadband Module
797517-001	A	Service cover for use only on RCTO models (includes rubber feet)
798955-001	A	128-GB, SATA-3, TLC, solid-state drive
798956-001	A	256-GB, SATA-3, TLC, solid-state drive

4 Removal and replacement preliminary requirements

Tools required

You will need the following tools to complete the removal and replacement procedures:

- Flat-bladed screw driver
- Magnetic screw driver
- Phillips P0 screw driver

Service considerations

The following sections include some of the considerations that you must keep in mind during disassembly and assembly procedures.

 **NOTE:** As you remove each subassembly from the computer, place the subassembly (and all accompanying screws) away from the work area to prevent damage.

Plastic parts

 **CAUTION:** Using excessive force during disassembly and reassembly can damage plastic parts. Use care when handling the plastic parts. Apply pressure only at the points designated in the maintenance instructions.

Cables and connectors

⚠ CAUTION: When servicing the computer, be sure that cables are placed in their proper locations during the reassembly process. Improper cable placement can damage the computer.

Cables must be handled with extreme care to avoid damage. Apply only the tension required to unseat or seat the cables during removal and insertion. Handle cables by the connector whenever possible. In all cases, avoid bending, twisting, or tearing cables. Be sure that cables are routed in such a way that they cannot be caught or snagged by parts being removed or replaced. Handle flex cables with extreme care; these cables tear easily.

Drive handling

⚠ CAUTION: Drives are fragile components that must be handled with care. To prevent damage to the computer, damage to a drive, or loss of information, observe these precautions:

Before removing or inserting a hard drive, shut down the computer. If you are unsure whether the computer is off or in Hibernation, turn the computer on, and then shut it down through the operating system.

Before handling a drive, be sure that you are discharged of static electricity. While handling a drive, avoid touching the connector.

Before removing a diskette drive or optical drive, be sure that a diskette or disc is not in the drive and be sure that the optical drive tray is closed.

Handle drives on surfaces covered with at least one inch of shock-proof foam.

Avoid dropping drives from any height onto any surface.

After removing a hard drive, an optical drive, or a diskette drive, place it in a static-proof bag.

Avoid exposing an internal hard drive to products that have magnetic fields, such as monitors or speakers.

Avoid exposing a drive to temperature extremes or liquids.

If a drive must be mailed, place the drive in a bubble pack mailer or other suitable form of protective packaging and label the package “FRAGILE.”

Grounding guidelines

Electrostatic discharge damage

Electronic components are sensitive to electrostatic discharge (ESD). Circuitry design and structure determine the degree of sensitivity. Networks built into many integrated circuits provide some protection, but in many cases, ESD contains enough power to alter device parameters or melt silicon junctions.

A discharge of static electricity from a finger or other conductor can destroy static-sensitive devices or microcircuitry. Even if the spark is neither felt nor heard, damage may have occurred.

An electronic device exposed to ESD may not be affected at all and can work perfectly throughout a normal cycle. Or the device may function normally for a while, then degrade in the internal layers, reducing its life expectancy.

⚠ CAUTION: To prevent damage to the computer when you are removing or installing internal components, observe these precautions:

Keep components in their electrostatic-safe containers until you are ready to install them.

Before touching an electronic component, discharge static electricity by using the guidelines described in this section.

Avoid touching pins, leads, and circuitry. Handle electronic components as little as possible.

If you remove a component, place it in an electrostatic-safe container.

The following table shows how humidity affects the electrostatic voltage levels generated by different activities.

⚠ CAUTION: A product can be degraded by as little as 700 V.

Typical electrostatic voltage levels			
Event	Relative humidity		
	10%	40%	55%
Walking across carpet	35,000 V	15,000 V	7,500 V
Walking across vinyl floor	12,000 V	5,000 V	3,000 V
Motions of bench worker	6,000 V	800 V	400 V
Removing DIPs from plastic tube	2,000 V	700 V	400 V
Removing DIPs from vinyl tray	11,500 V	4,000 V	2,000 V
Removing DIPs from Styrofoam	14,500 V	5,000 V	3,500 V
Removing bubble pack from PCB	26,500 V	20,000 V	7,000 V
Packing PCBs in foam-lined box	21,000 V	11,000 V	5,000 V

Packaging and transporting guidelines

Follow these grounding guidelines when packaging and transporting equipment:

- To avoid hand contact, transport products in static-safe tubes, bags, or boxes.
- Protect ESD-sensitive parts and assemblies with conductive or approved containers or packaging.
- Keep ESD-sensitive parts in their containers until the parts arrive at static-free workstations.
- Place items on a grounded surface before removing items from their containers.
- Always be properly grounded when touching a component or assembly.
- Store reusable ESD-sensitive parts from assemblies in protective packaging or nonconductive foam.
- Use transporters and conveyors made of antistatic belts and roller bushings. Be sure that mechanized equipment used for moving materials is wired to ground and that proper materials are selected to avoid static charging. When grounding is not possible, use an ionizer to dissipate electric charges.

Workstation guidelines

Follow these grounding workstation guidelines:

- Cover the workstation with approved static-shielding material.
- Use a wrist strap connected to a properly grounded work surface and use properly grounded tools and equipment.
- Use conductive field service tools, such as cutters, screw drivers, and vacuums.
- When fixtures must directly contact dissipative surfaces, use fixtures made only of static-safe materials.
- Keep the work area free of nonconductive materials, such as ordinary plastic assembly aids and Styrofoam.
- Handle ESD-sensitive components, parts, and assemblies by the case or PCM laminate. Handle these items only at static-free workstations.
- Avoid contact with pins, leads, or circuitry.
- Turn off power and input signals before inserting or removing connectors or test equipment.

Equipment guidelines

Grounding equipment must include either a wrist strap or a foot strap at a grounded workstation.

- When seated, wear a wrist strap connected to a grounded system. Wrist straps are flexible straps with a minimum of one megohm $\pm 10\%$ resistance in the ground cords. To provide proper ground, wear a strap snugly against the skin at all times. On grounded mats with banana-plug connectors, use alligator clips to connect a wrist strap.
- When standing, use foot straps and a grounded floor mat. Foot straps (heel, toe, or boot straps) can be used at standing workstations and are compatible with most types of shoes or boots. On conductive floors or dissipative floor mats, use foot straps on both feet with a minimum of one megohm resistance between the operator and ground. To be effective, the conductive must be worn in contact with the skin.

The following grounding equipment is recommended to prevent electrostatic damage:

- Antistatic tape
- Antistatic smocks, aprons, and sleeve protectors
- Conductive bins and other assembly or soldering aids
- Nonconductive foam
- Conductive computerop workstations with ground cords of one megohm resistance
- Static-dissipative tables or floor mats with hard ties to the ground
- Field service kits
- Static awareness labels
- Material-handling packages
- Nonconductive plastic bags, tubes, or boxes
- Metal tote boxes
- Electrostatic voltage levels and protective materials

The following table lists the shielding protection provided by antistatic bags and floor mats.

Material	Use	Voltage protection level
Antistatic plastics	Bags	1,500 V
Carbon-loaded plastic	Floor mats	7,500 V
Metallized laminate	Floor mats	5,000 V

5 Removal and replacement procedures for Customer Self-Repair parts

 **NOTE:** The Customer Self-Repair program is not available in all locations. Installing a part not supported by the Customer Self-Repair program may void your warranty. Check your warranty to determine if Customer Self-Repair is supported in your location.

 **NOTE:** HP continually improves and changes product parts. For complete and current information on supported parts for your computer, go to <http://partsurfer.hp.com>, select your country or region, and then follow the on-screen instructions.

Component replacement procedures

This chapter provides removal and replacement procedures for Authorized Service Provider only parts.

There are as many as 15 screws that must be removed, replaced, and/or loosened when servicing the computer. Make special note of each screw size and location during removal and replacement.

Service cover

 **NOTE:** The service cover spare part kit includes rubber feet.

Description	Spare part number
Service cover for use in 820 G2 models	781836-001
Service cover for use in 720 G2 models	790080-001
Service cover for use only on RCT0 models	797517-001

Before removing the disassembling the computer, follow these steps:

1. Turn off the computer. If you are unsure whether the computer is off or in Hibernation, turn the computer on, and then shut it down through the operating system.
2. Disconnect the power from the computer by unplugging the power cord from the computer.
3. Disconnect all external devices from the computer.

Remove the service cover:

1. Turn the computer upside down, with the rear toward you.
2. Slide the service cover release latch **(1)** to gain access to the service cover security screw.
3. Remove the Phillips PM2.0×4.5 security screw **(2)** (if present).

 **NOTE:** The service cover includes a threaded receptacle for storing the security screw.

4. Slide the service cover release latch a second time **(3)** to release the service cover.
5. Release the service cover **(4)** by sliding it forward.

6. Remove the service cover (5).

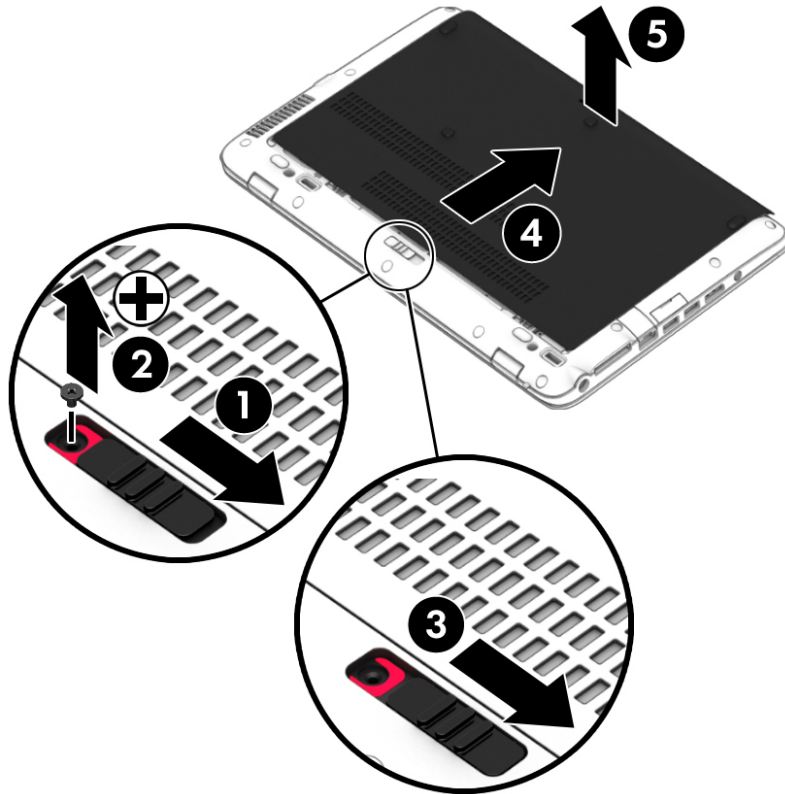

Reverse this procedure to install the service cover.

Battery

Description	Spare part number
3-cell, 46-WHr, 4.15-AHr, Li-ion battery	717378-001
3-cell, 26-WHr, 2.50-AHr, Li-ion battery	717377-001

Before removing the battery, follow these steps:

1. Turn off the computer. If you are unsure whether the computer is off or in Hibernation, turn the computer on, and then shut it down through the operating system.
2. Disconnect the power from the computer by unplugging the power cord from the computer.
3. Disconnect all external devices from the computer.
4. Remove the service cover (see [Service cover on page 46](#)).

 **WARNING!** To reduce potential safety issues, use only the battery provided with the computer, a replacement battery provided by HP, or a compatible battery purchased from HP.

 **CAUTION:** Removing a battery that is the sole power source for the computer can cause loss of information. To prevent loss of information, save your work or shut down the computer through Windows before removing the battery.

Remove the battery:

1. Slide the battery lock latches **(1)** to unlock the battery.

2. Use the release tab **(2)** to lift the rear edge of the battery **(3)** until the battery rests at an angle.

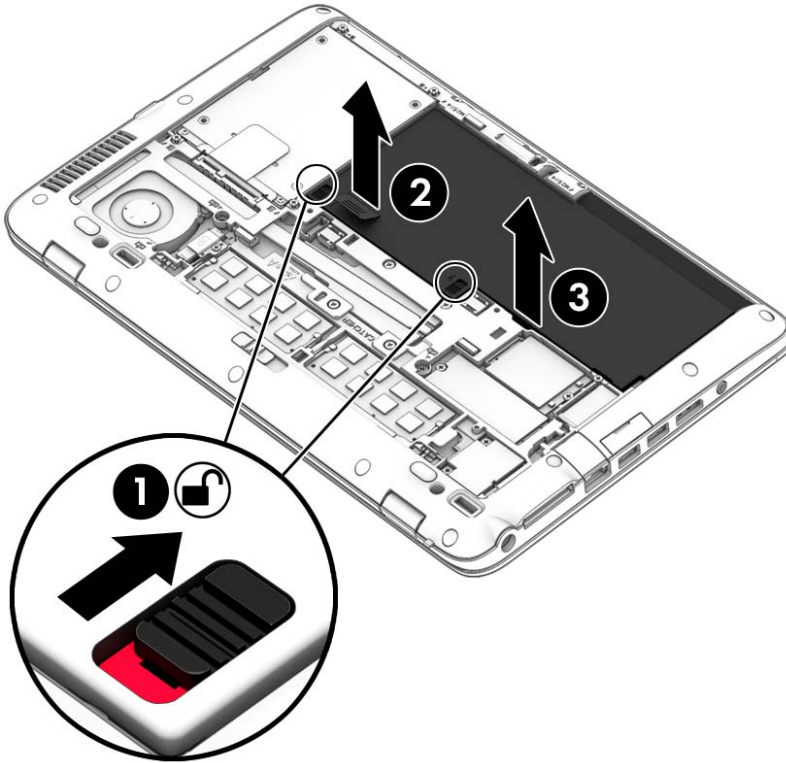

3. Remove the battery.

Reverse this procedure to install the battery.

Hard drive



NOTE: The hard drive spare part kit does not include the hard drive bracket, hard drive connector adapter, or screws. The hard drive bracket, hard drive connector adapter, and screws are included in the Hard Drive Hardware Kit, spare part number 730539-001.

Description	Spare part number
For use on all computer models:	
1-TB, 5400-rpm, SATA, 7.0-mm hard drive	762990-001
500-GB, 7200-rpm, SATA, 7.0-mm hard drive	703267-001
500-GB, 7200-rpm, SED, 7.0-mm hard drive	703268-001
500-GB, 5400-rpm, SATA, FIPS, 7.0-mm hard drive	730946-001
320-GB, 7200-rpm, SATA, 7.0-mm hard drive	778184-001

Before removing the battery, follow these steps:

1. Turn off the computer. If you are unsure whether the computer is off or in Hibernation, turn the computer on, and then shut it down through the operating system.
2. Disconnect the power from the computer by unplugging the power cord from the computer.
3. Disconnect all external devices from the computer.
4. Remove the service cover (see [Service cover on page 46](#)).
5. Remove the battery (see [Battery on page 48](#)).

Remove the hard drive:

1. Loosen the four Phillips captive screws **(1)** that secure the hard drive to the computer.

2. Use the release tab **(2)** to remove the hard drive.

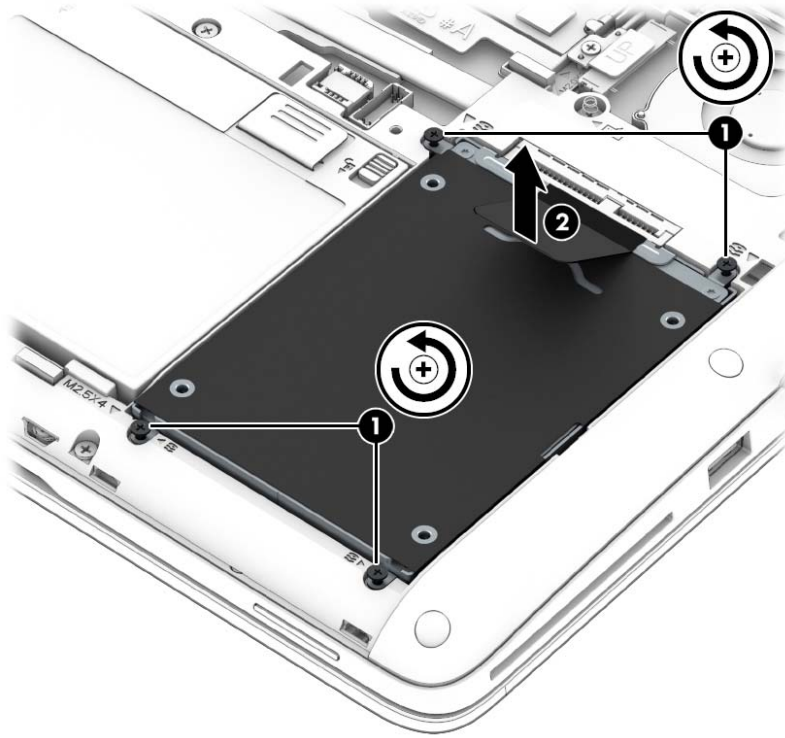

3. If it is necessary to disassemble the hard drive, perform the following steps:
 - a. Position the hard drive with the rear toward you.
 - b. Remove the four Phillips PM2.75×3.5 screws **(1)** that secure the hard drive bracket to the hard drive.
 - c. Remove the hard drive bracket **(2)** from the hard drive.

- d. Remove the hard drive connector adapter **(3)** from the hard drive.

The hard drive bracket, hard drive connector adapter, and screws are available in the Hard Drive Hardware Kit, spare part number 730539-001.

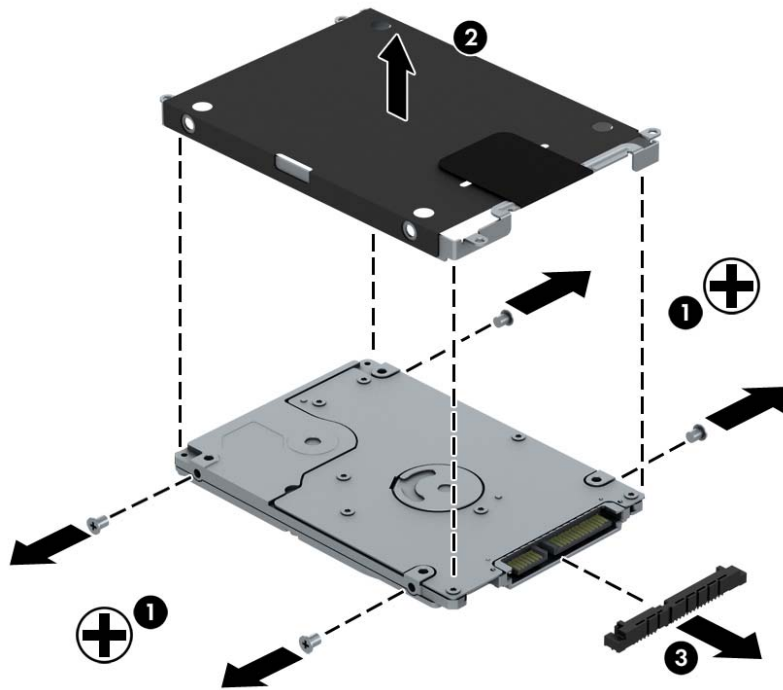

Reverse this procedure to reassemble and install the hard drive.

WWAN module

Description	Spare part number
HP hs3110 HSPA+ Mobile Broadband Module	793516-001
HP lt4112 LTE/HSPA+ Mobile Broadband Module	790198-001
HP lt4111 LTE/EV-DO/HSPA+ Mobile Broadband Module	793116-001

Before removing the WWAN module, follow these steps:

1. Turn off the computer. If you are unsure whether the computer is off or in Hibernation, turn the computer on, and then shut it down through the operating system.
2. Disconnect the power from the computer by unplugging the power cord from the computer.
3. Disconnect all external devices from the computer.
4. Remove the service cover (see [Service cover on page 46](#)).
5. Remove the battery (see [Battery on page 48](#)).

Remove the WWAN module:

1. Disconnect the WWAN antenna cables **(1)** from the terminals on the WWAN module.



NOTE: The WWAN antenna cable labeled “5” connects to the WWAN module “Main” terminal labeled “5”. The WWAN antenna cable labeled “6” connects to the WWAN module “Aux/GPS” terminal labeled “6”.

2. Remove the Phillips PM2.0×2.5 screw **(2)** that secures the WWAN module to the system board. (The WWAN module tilts up.)

3. Remove the WWAN module (3) by pulling the module away from the slot at an angle.

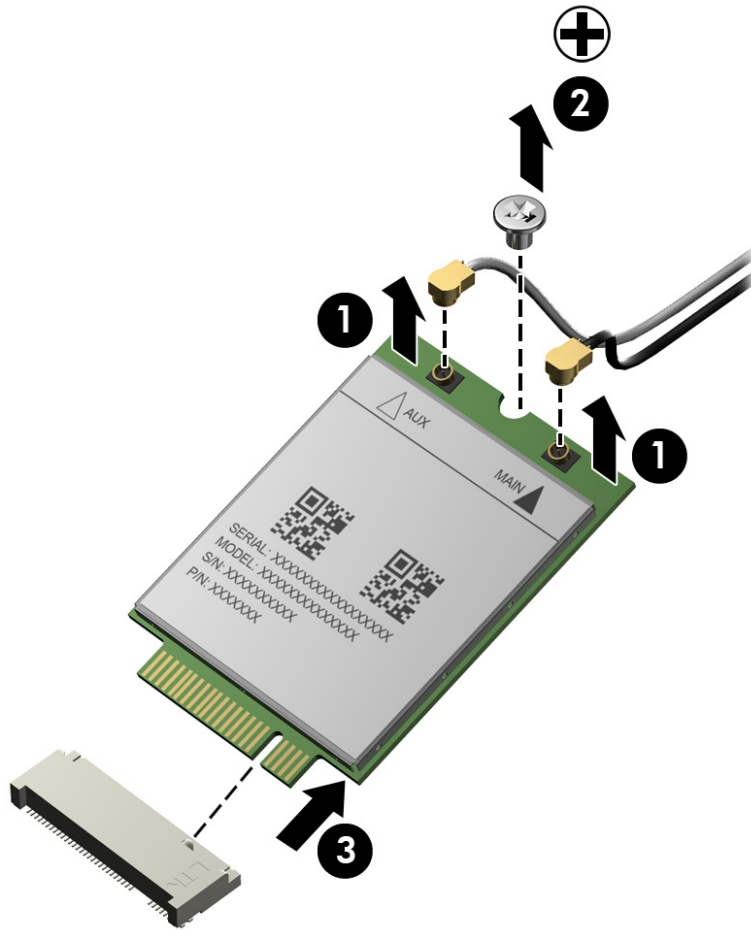

NOTE: If the WWAN antenna cables are not connected to the terminals on the WWAN module, protective sleeves should be installed on the antenna connectors, as shown in the following illustration.

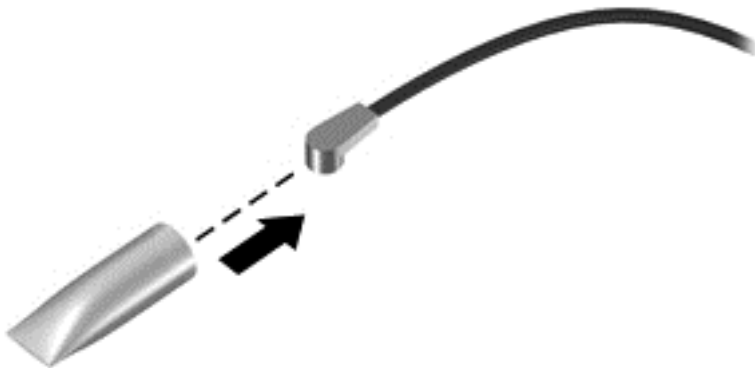

Reverse this procedure to install the WWAN module.

Solid-state drive

Description	Spare part number
512-GB, SATA-3, solid-state drive	781850-001
256-GB, SATA-3, SED, Opal 2, solid-state drive	781849-001
256-GB, SATA-3, TLC, solid-state drive	798956-001
256-GB, M.2, PCIe, solid-state drive	781853-001
240-GB, SATA-3, solid-state drive	781847-001
180-GB, SATA-3, SED, Opal 2, solid-state drive	781846-001
180-GB, SATA-3, solid-state drive	781843-001
128-GB, SATA-3, TLC, solid-state drive	798955-001
128-GB, SATA-3, solid-state drive	781842-001
120-GB, SATA-3, M.2, solid-state drive	781852-001
32-GB, SATA-3, M.2, solid-state drive	781851-001

Before removing the solid-state drive, follow these steps:

1. Turn off the computer. If you are unsure whether the computer is off or in Hibernation, turn the computer on, and then shut it down through the operating system.
2. Disconnect the power from the computer by unplugging the power cord from the computer.
3. Disconnect all external devices from the computer.
4. Remove the service cover (see [Service cover on page 46](#)).
5. Remove the battery (see [Battery on page 48](#)).

Remove the solid-state drive:

1. Remove the Phillips PM2.0×2.5 screw **(1)** that secures the solid-state drive to the system board. (The solid-state drive tilts up.)

2. Remove the solid-state drive **(2)** by pulling the drive away from the slot at an angle.

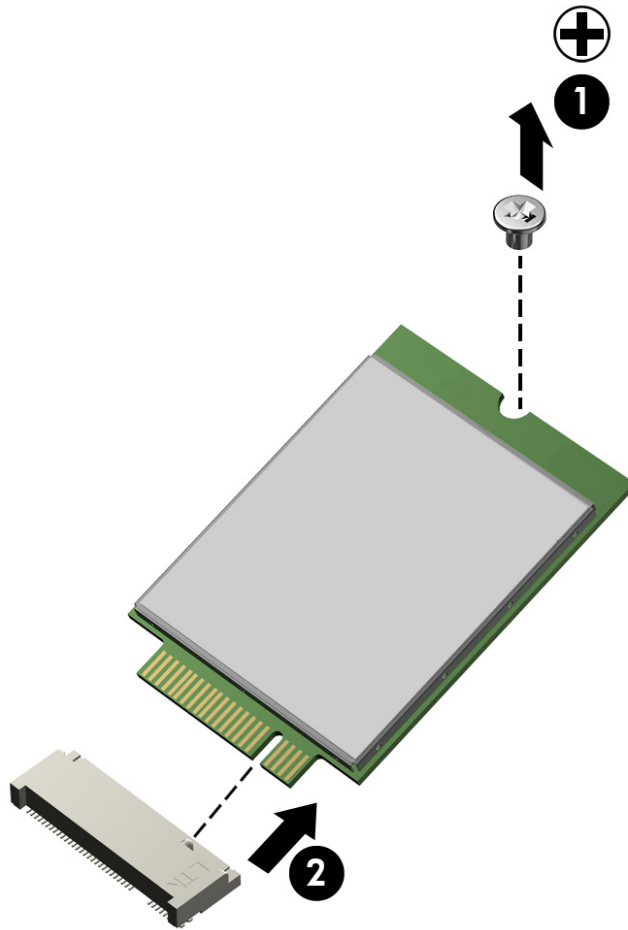

Reverse this procedure to install the solid-state drive.

WLAN module

Description	Spare part number
Intel Dual Band Wireless-AC 7265AN 802.11 a/b/g/n 2×2 WiFi + Bluetooth 4.0 WLAN module	756748-001
Intel Dual Band Wireless-N 7265 802.11 a/c 2×2 WiFi + Bluetooth 4.0 Combo Adapter	756749-001
Intel Dual Band Wireless-N 7265 802.11 a/c 2×2 WiFi + Bluetooth 4.0 Combo Adapter for use in Indonesia	783721-001
Intel Dual Band Wireless-AC 3160 802.11 a/b/g/n+a/c 2×2 WiFi Adapter	784644-001

Before removing the WLAN module, follow these steps:

1. Turn off the computer. If you are unsure whether the computer is off or in Hibernation, turn the computer on, and then shut it down through the operating system.
2. Disconnect the power from the computer by unplugging the power cord from the computer.
3. Disconnect all external devices from the computer.
4. Remove the service cover (see [Service cover on page 46](#)).
5. Remove the battery (see [Battery on page 48](#)).

Remove the WLAN module:

1. Disconnect the WLAN antenna cables **(1)** from the terminals on the WLAN module.



NOTE: The WLAN antenna cable labeled “1” connects to the WLAN module “Main” terminal labeled “1”. The WLAN antenna cable labeled “2” connects to the WLAN module “Aux” terminal labeled “2”.

2. Remove the Phillips PM2.0×2.0 screw **(2)** that secures the WLAN module to the system board. (The WLAN module tilts up.)

3. Remove the WLAN module (3) by pulling the module away from the slot at an angle.

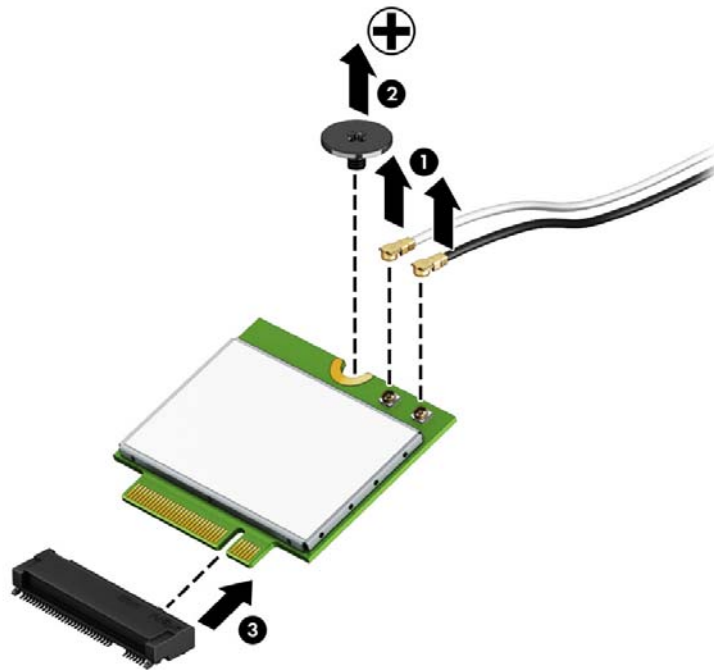

 **NOTE:** If the WLAN antenna cables are not connected to the terminals on the WLAN module, protective sleeves should be installed on the antenna connectors, as shown in the following illustration.



Reverse this procedure to install the WLAN module.

Memory module

Description	Spare part number
8 GB (PCL3, 12800, 1600-MHz)	693374-001
4 GB (PCL3, 12800, 1600-MHz)	691740-001

Before removing the memory module, follow these steps:

1. Turn off the computer. If you are unsure whether the computer is off or in Hibernation, turn the computer on, and then shut it down through the operating system.
2. Disconnect the power from the computer by unplugging the power cord from the computer.
3. Disconnect all external devices from the computer.
4. Remove the service cover (see [Service cover on page 46](#)).
5. Remove the battery (see [Battery on page 48](#)).

Remove the memory module:

1. Spread the retaining tabs **(1)** on each side of the memory module slot to release the memory module. (The memory module tilts up.)
2. Remove the memory module **(2)** by pulling the module away from the slot at an angle.

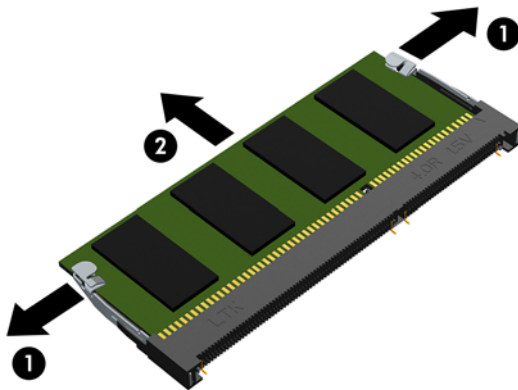

Reverse this procedure to install a memory module.

Keyboard

For use in country or region	Spare part number	For use in country or region	Spare part number
Keyboard with backlight (includes backlight cable and keyboard cable):			
For use in Belgium	776452-A41	For use in Northwest Africa	776452-FP1
For use in Brazil	776452-201	For use in Norway	776452-091
For use in Bulgaria	776452-261	For use in Portugal	776452-131
For use in Canada	776452-DB1	For use in Romania	776452-271
For use in the Czech Republic and Slovakia	776452-FL1	For use in the Russia	776452-251
For use in Denmark	776452-081	For use in Saudi Arabia	776452-171
For use in France	776452-051	For use in Slovenia	776452-BA1
For use in Germany	776452-041	For use in South Korea	776452-AD1
For use in Greece	776452-151	For use in Spain	776452-071
For use in Hungary	776452-211	For use in Sweden and Finland	776452-B71
For use in Iceland	776452-DD1	For use in Switzerland	776452-BG1
For use in India	776452-D61	For use in Taiwan	776452-AB1
For use in Israel	776452-BB1	For use in Thailand	776452-281
For use in Italy	776452-061	For use in Turkey	776452-141
For use in Japan	776452-291	For use in the United Kingdom	776452-031
For use in Latin America	776452-161	For use in the United States	776452-001
For use in the Netherlands	776452-B31		
Keyboard without backlight (includes keyboard cable):			
For use in Belgium	776451-A41	For use in Northwest Africa	776451-FP1
For use in Brazil	776451-201	For use in Norway	776451-091
For use in Bulgaria	776451-261	For use in Portugal	776451-131
For use in Canada	776451-DB1	For use in Romania	776451-271
For use in the Czech Republic and Slovakia	776451-FL1	For use in the Russia	776451-251
For use in Denmark	776451-081	For use in Saudi Arabia	776451-171
For use in France	776451-051	For use in Slovenia	776451-BA1
For use in Germany	776451-041	For use in South Korea	776451-AD1
For use in Greece	776451-151	For use in Spain	776451-071
For use in Hungary	776451-211	For use in Sweden and Finland	776451-B71
For use in Iceland	776451-DD1	For use in Switzerland	776451-BG1
For use in India	776451-D61	For use in Taiwan	776451-AB1
For use in Israel	776451-BB1	For use in Thailand	776451-281

For use in country or region	Spare part number	For use in country or region	Spare part number
For use in Italy	776451-061	For use in Turkey	776451-141
For use in Japan	776451-291	For use in the United Kingdom	776451-031
For use in Latin America	776451-161	For use in the United States	776451-001
For use in the Netherlands	776451-B31		

Before removing the keyboard, follow these steps:

1. Turn off the computer. If you are unsure whether the computer is off or in Hibernation, turn the computer on, and then shut it down through the operating system.
2. Disconnect the power from the computer by unplugging the power cord from the computer.
3. Disconnect all external devices from the computer.
4. Remove the service cover (see [Service cover on page 46](#)).
5. Remove the battery (see [Battery on page 48](#)).

Remove the keyboard:

1. Loosen the two captive screws that secure the keyboard to the computer.

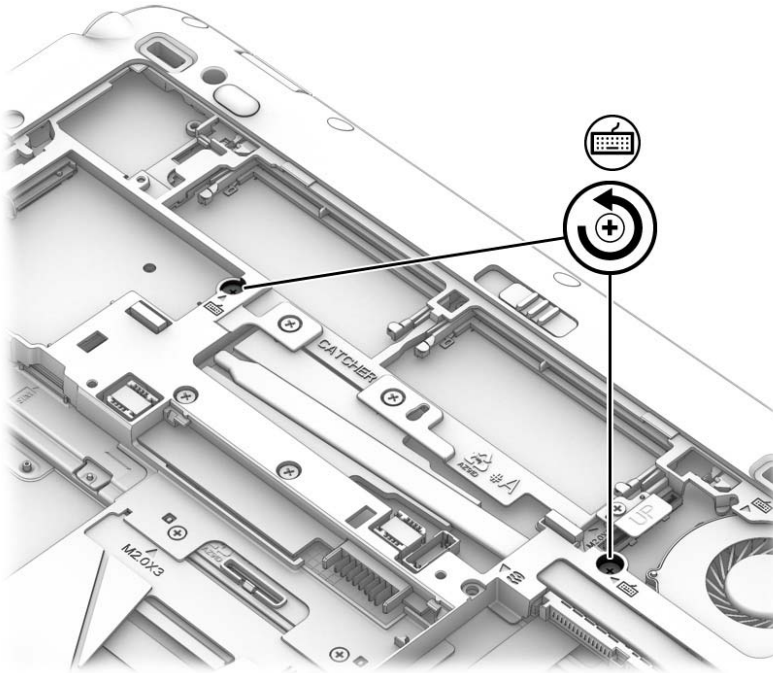

2. Partially open the computer.
3. Rest and secure the computer on its left side.

4. Insert a thin, plastic tool into the keyboard release hole next to the fan, and then press on the back of the keyboard until the keyboard disengages from the computer.

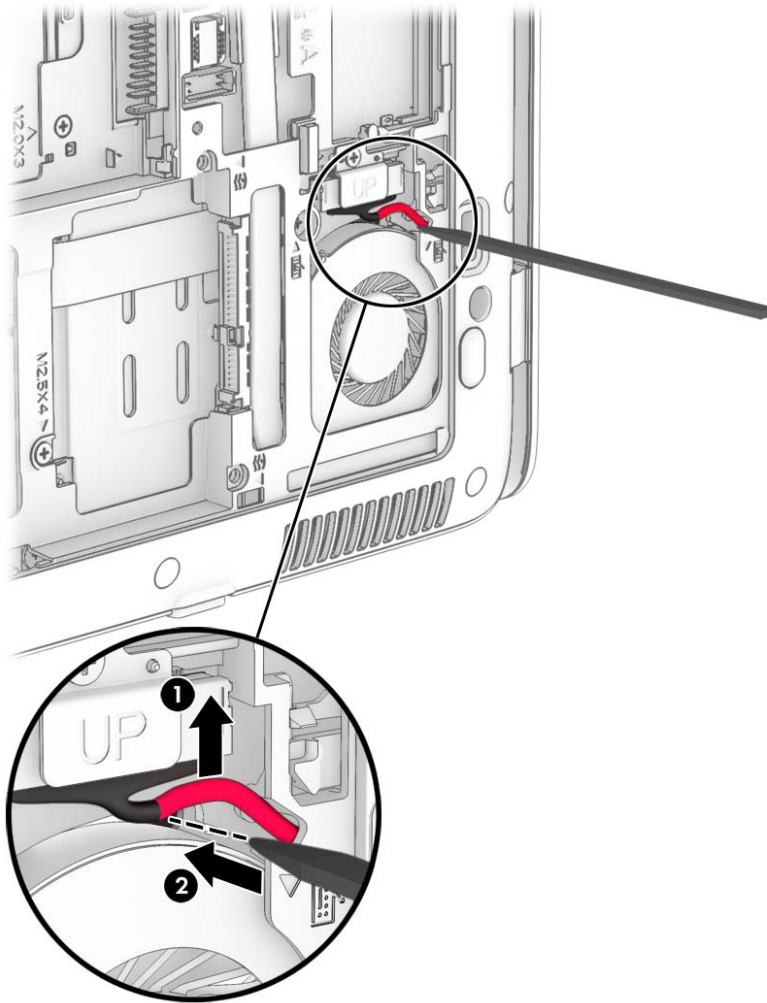

5. Open the computer as far as it will open.
6. Lift the rear edge of the keyboard **(1)** until it rests at an angle.
7. Slide the keyboard **(2)** toward the display until the tabs on the front edge of the keyboard disengage from the top cover.

8. Swing the rear edge of the keyboard **(3)** up and forward until it rests upside down on the palm rest.

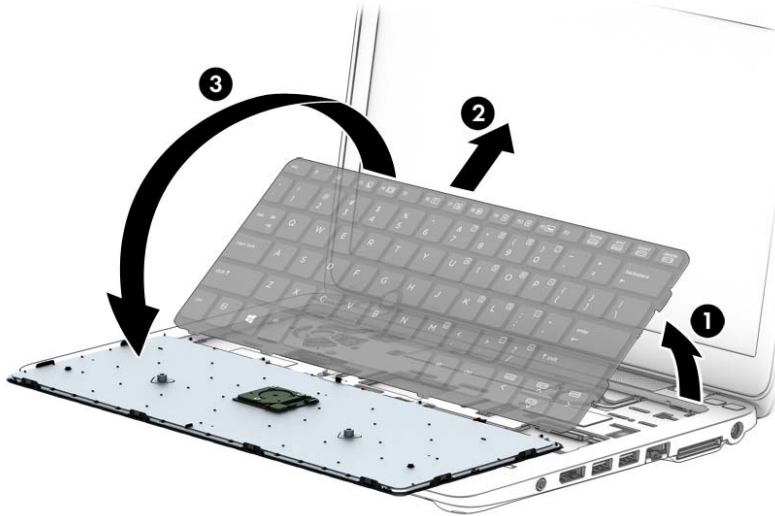

NOTE: Step 9 applies only to computer models equipped with a keyboard with backlight.

9. Release the zero insertion force (ZIF) connector **(1)** to which the backlight cable is attached, and then disconnect the backlight cable **(2)** from the system board.
10. Release the ZIF connector **(3)** to which the keyboard cable is attached, and then disconnect the keyboard cable **(4)** from the system board.
11. Release the ZIF connector **(5)** to which the pointing stick cable is attached, and then disconnect the pointing stick cable **(6)** from the system board.

12. Remove the keyboard (7).

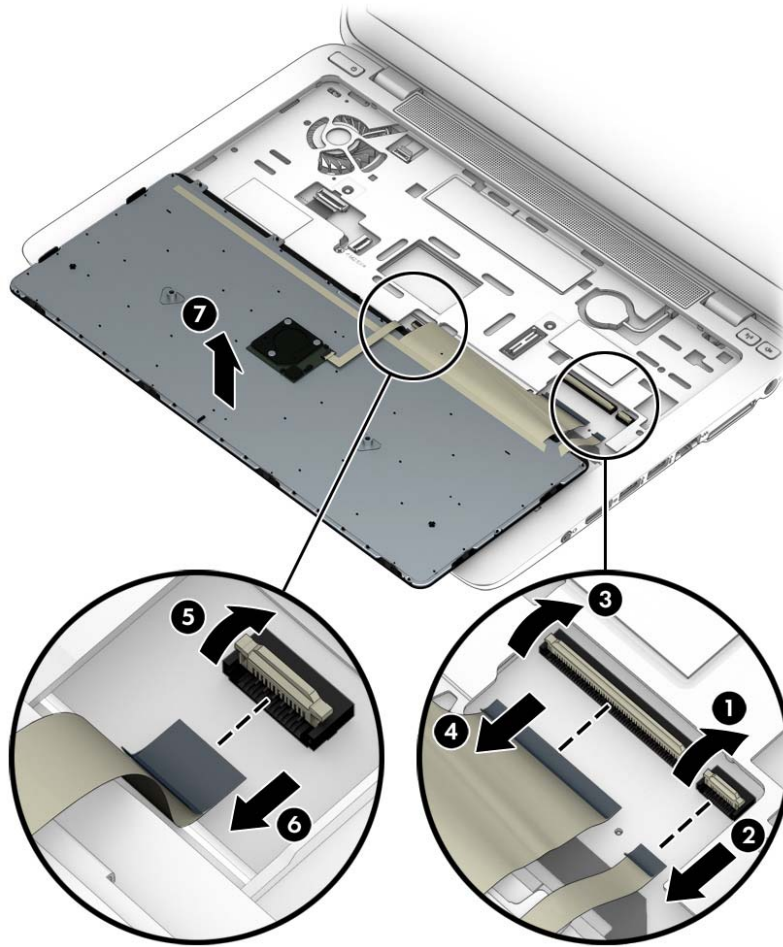

Reverse this procedure to install the keyboard.

6 Removal and replacement procedures for Authorized Service Provider parts

 **NOTE:** Components described in this chapter should only be accessed by an authorized service provider. Accessing these parts can damage the computer or void the warranty.

 **NOTE:** HP continually improves and changes product parts. For complete and current information on supported parts for your computer, go to <http://partsurfer.hp.com>, select your country or region, and then follow the on-screen instructions.

Component replacement procedures

This chapter provides removal and replacement procedures for Authorized Service Provider only parts.

There are as many as 54 screws that must be removed, replaced, and/or loosened when servicing the computer. Make special note of each screw size and location during removal and replacement.

Unlocking the device and disabling Always On Remote Management (select HP devices only)

HP Touchpoint Manager (HPTM) is a complete cloud-based solution for managing devices. For select HP devices with the Windows operating system, the Always On Remote Management (AORM) feature is automatically activated when HP Touchpoint Manager software is installed.

AORM can perform a secure BIOS level lock and can also securely erase internal drives (except for encrypted self-encrypting drives). The HP Touchpoint Manager website (<http://www.hptouchpointmanager.com>) provides access to the AORM lock feature. The device must be unlocked using an authorized PIN from the same website before you can access HP Computer Setup and start the Windows operating system.

 **IMPORTANT:** A service agent cannot retrieve the PIN from the HP Touchpoint Manager website. If a locked device is returned for service, the agent must contact the customer to obtain the PIN to unlock the device. If a PIN is not available, the entire system board must be replaced.

Before returning the device for service, be sure to unlock the device using the PIN from the HP Touchpoint Manager website (<http://www.hptouchpointmanager.com>), and also disable the AORM feature in HP Computer Setup.

To disable AORM:

1. Access HP Computer Setup (F10).
 - a. Turn on or restart the computer, and then press **esc** while the “Press the ESC key for Startup Menu” message is displayed at the bottom of the screen.
 - b. Press **f10** to enter Computer Setup.

 **NOTE:** If the BIOS is protected with an Administrator password, enter the password.

2. Select **Advanced** and then select **HP Touchpoint Manager Options**.
3. Clear the **Allow Activation** check box.
4. Select **Save changes and exit..**

RTC battery

Description	Spare part number
RTC battery (includes cable and double-sided adhesive)	702853-001

Before removing the RTC battery, follow these steps:

1. Turn off the computer. If you are unsure whether the computer is off or in Hibernation, turn the computer on, and then shut it down through the operating system.
2. Disconnect the power from the computer by unplugging the power cord from the computer.
3. Disconnect all external devices from the computer.
4. Remove the service cover (see [Service cover on page 46](#)).
5. Remove the battery (see [Battery on page 48](#)).
6. Remove the keyboard (see [Keyboard on page 60](#)).

Remove the RTC battery:

1. Disconnect the RTC battery cable (**1**) from the system board.
2. Detach the RTC battery (**2**) from the top cover. (The RTC battery is attached to the top cover with double-sided adhesive.)

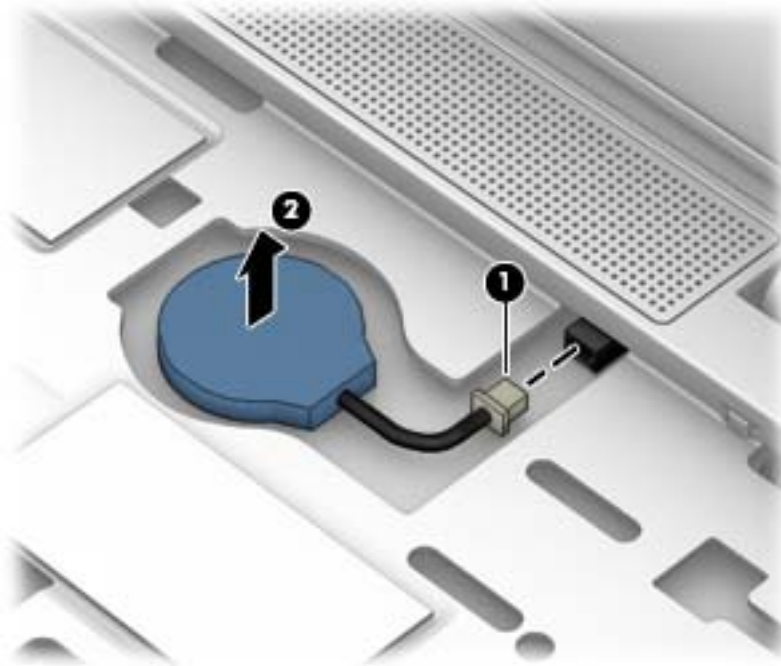

3. Remove the RTC battery and cable.

Reverse this procedure to install the RTC battery.

Top cover

Description	Spare part number
Top cover	783215-001

Before removing the top cover, follow these steps:

1. Turn off the computer. If you are unsure whether the computer is off or in Hibernation, turn the computer on, and then shut it down through the operating system.
2. Disconnect the power from the computer by unplugging the power cord from the computer.
3. Disconnect all external devices from the computer.
4. Remove the service cover (see [Service cover on page 46](#)), and then remove the following components:
 - a. Battery (see [Battery on page 48](#))
 - b. Hard drive (see [Hard drive on page 50](#))
 - c. Keyboard (see [Keyboard on page 60](#))



NOTE: When replacing the top cover, be sure that the following components are removed from the defective top cover and installed on the replacement top cover:

Remove the top cover:

1. Close the computer.
2. Turn the computer upside down with the front toward you.
3. Remove the Phillips PM2.0×3.25 screw **(1)** that secures the display panel cable bracket and display panel cable to the system board.
4. Remove the display panel cable bracket **(2)**.

5. Disconnect the display panel cable **(3)** from the system board.

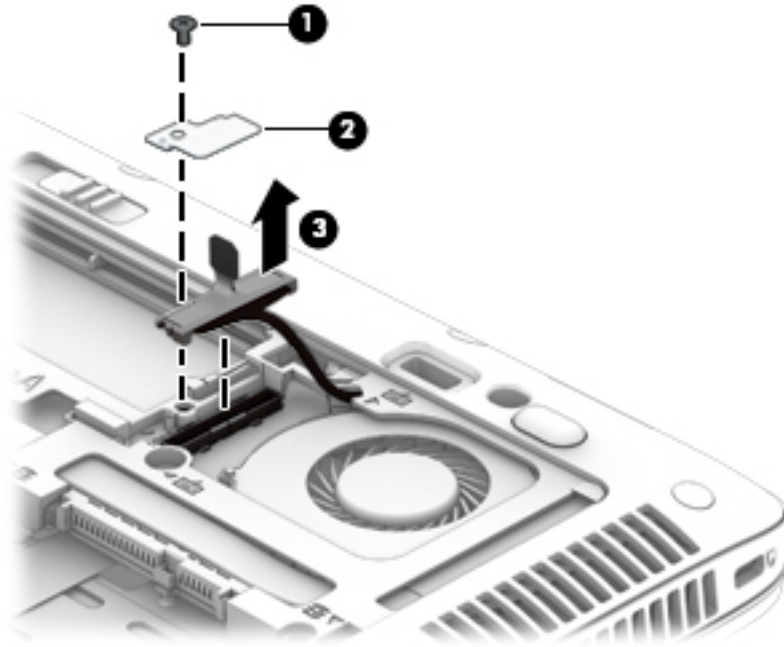

6. Remove the following rubber screw covers:
 - (1)** This screw cover has a “1” marking on the inside of the cover
 - (2)** These screw covers have a “2” marking on the inside of the cover
 - (3)** These screw covers have a “3” marking on the inside of the cover
7. Remove the card reader bezel **(4)** from the card reader slot.

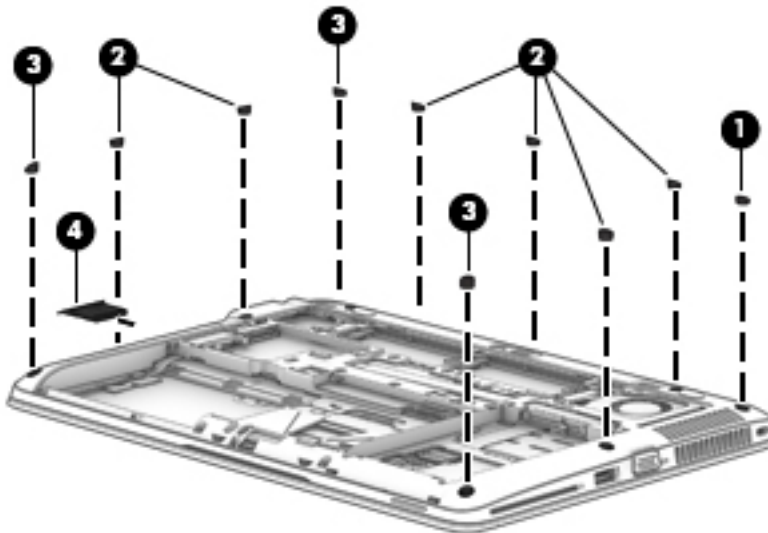

8. Remove the ten Torx T8M2.5×6.5 screws that secure the top cover to the base enclosure.

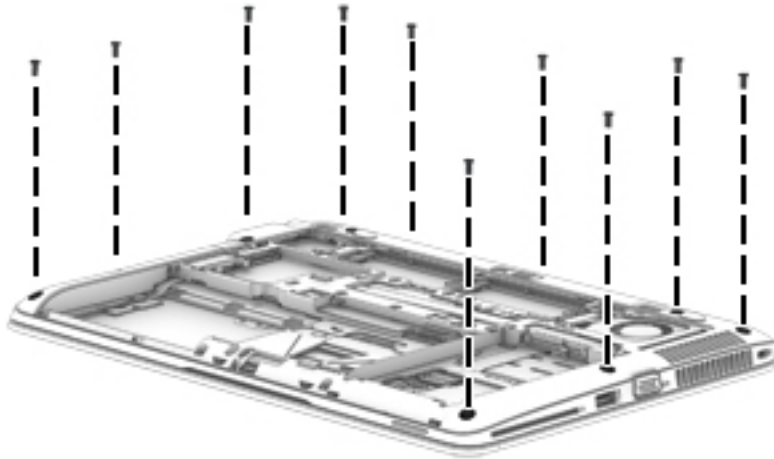

9. Remove the following screws that secure the top cover to the base enclosure:

- (1) One Phillips PM2.0×6.5 screw
- (2) Three Phillips PM2.5×4.5 screws
- (3) Two Phillips PM2.0×3.0 screws

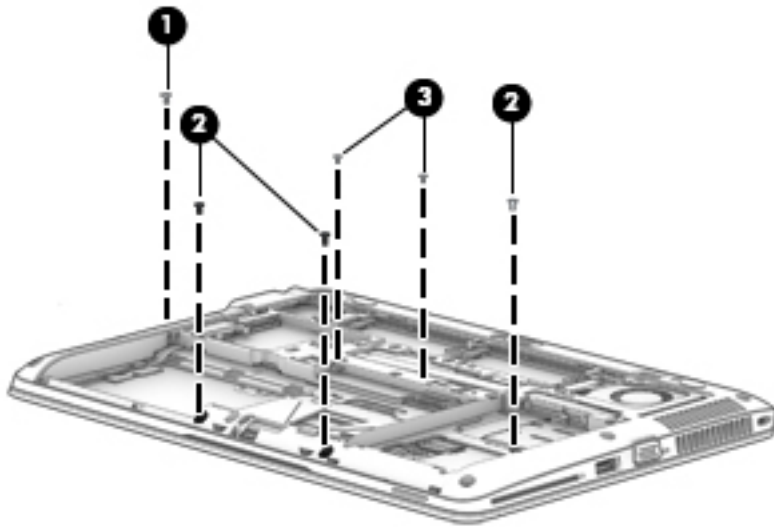

10. Remove the two Phillips PM2.5×4.5 screws (1) that secure the top cover to the base enclosure.

11. Remove the top cover (2).

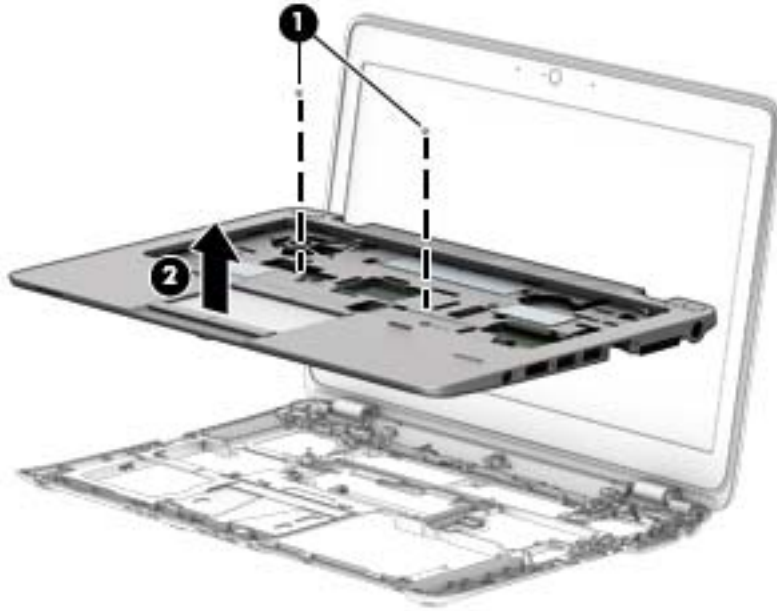

Reverse this procedure to install the top cover.

Display assembly

 **NOTE:** The TouchScreen display assembly is spared as a whole unit replacement. The non-TouchScreen display assembly is spared at the subcomponent level only. For more display assembly spare part information, see the individual removal subsections.

Description	Spare part number
12.5-in, AntiGlare, FHD, LED, UWVA, TouchScreen display assembly	781838-001

Before removing the display assembly, follow these steps:

1. Turn off the computer. If you are unsure whether the computer is off or in Hibernation, turn the computer on, and then shut it down through the operating system.
2. Disconnect the power from the computer by unplugging the power cord from the computer.
3. Disconnect all external devices from the computer.
4. Remove the service cover (see [Service cover on page 46](#)), and then remove the following components:
 - a. Battery (see [Battery on page 48](#))
 - b. Hard drive (see [Hard drive on page 50](#))
 - c. Keyboard (see [Keyboard on page 60](#))
 - d. Top cover (see [Top cover on page 67](#))

Remove the display assembly:

1. Release the display panel cable from the routing clips **(1)** and channel built into the base enclosure.
2. Release the wireless antenna cables from the routing clips **(2)** and channel built into the base enclosure.

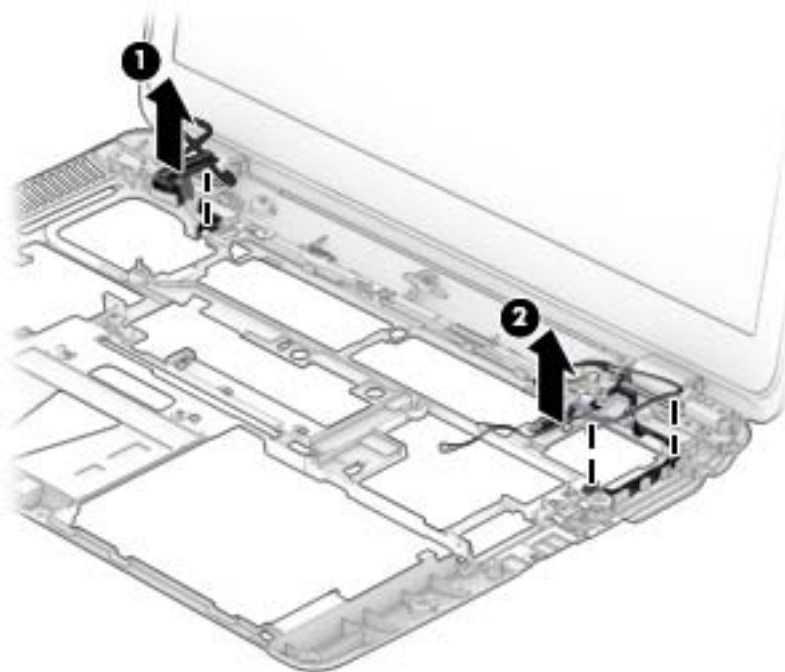

3. Remove the four Phillips PM2.5×4.5 screws **(1)** that secure the display assembly to the base enclosure.

4. Remove the display assembly **(2)**.

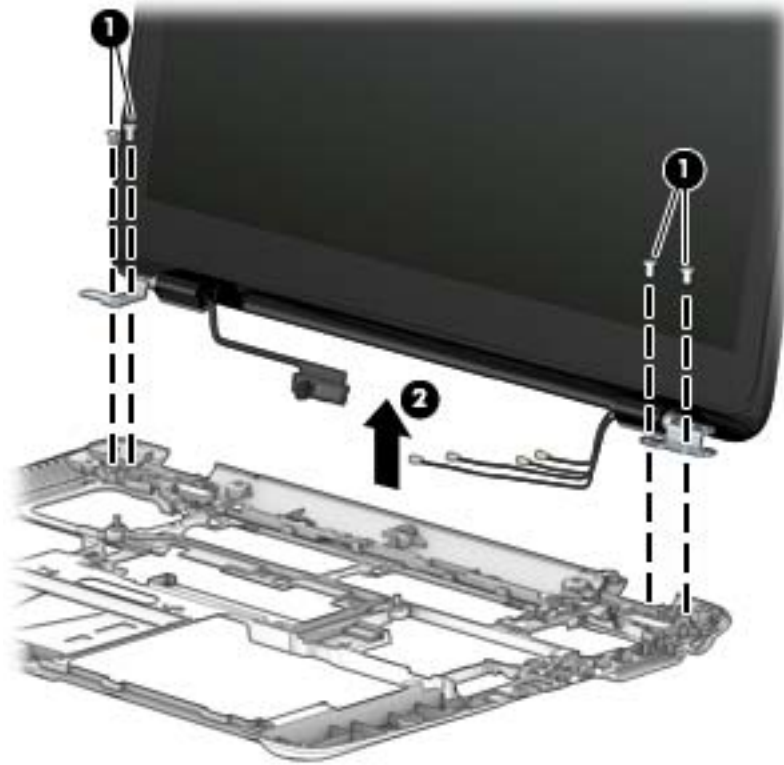

5. If it is necessary to replace the display bezel or any of the display assembly subcomponents:
 - a. Flex the inside edges of the top edge **(1)**, the left and right sides **(2)**, and the bottom edge **(3)** of the display bezel until the bezel disengages from the display enclosure.
 - b. Remove the display bezel **(4)**.

The display bezel is available using the following spare part numbers:

- 786930-001: For use on 720 G2 models with an HD display panel
- 790381-001: For use on 720 G2 models with an FHD display panel
- 730544-001: For use on 820 G2 models with an HD display panel
- 781837-001: For use on 820 G2 models with an FHD display panel

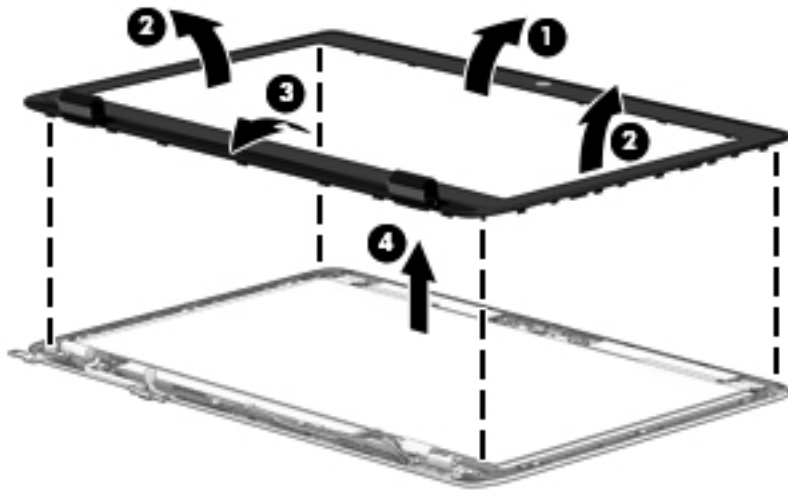

6. If it is necessary to replace the display panel:

- a. Remove the six Phillips PM2.0×3.25 screws **(1)** that secure the display panel to the display enclosure.

⚠ CAUTION: Before turning the display panel upside down, make sure the work surface is clear of tools, screws, and any other foreign objects. Failure to follow this caution can result in damage to the display panel.

- b. Lift the top edge of the display panel **(2)** and swing it up and forward until it rests upside down in front of the display enclosure.

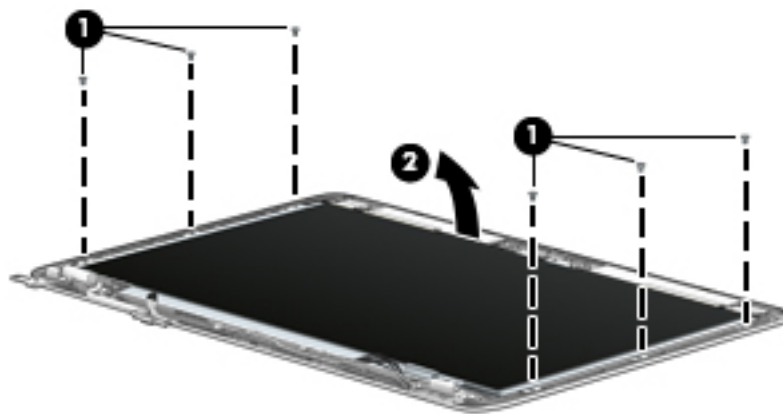

- c. Release the adhesive strip **(1)** that secures the display panel cable connector to the display panel.

- d. Disconnect the display panel cable **(2)** from the display panel.

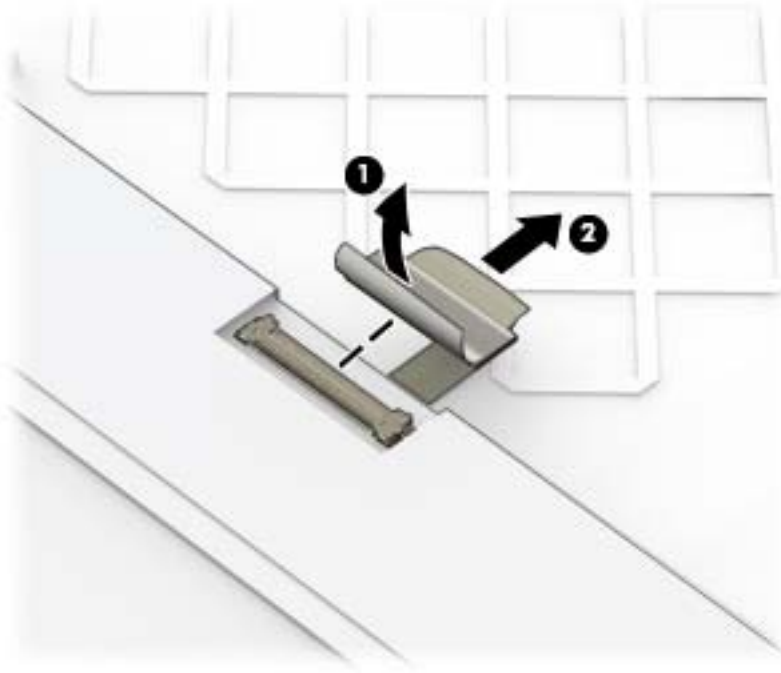

- e. Remove the display panel.
- The display panel is available using the following spare part numbers:
- 781864-00: 12.5-in, AG, FHD, LED, UWVA display panel
 - 781863-001: 12.5-in, AG, HD, LED, SVA display panel
7. If it is necessary to replace the webcam/microphone module or the microphone module:
- a. Detach the webcam/microphone module **(1)** from the display enclosure. (The webcam/microphone module is attached to the display enclosure with double-sided adhesive.)
 - b. Disconnect the webcam/microphone module cable **(2)** from the webcam/ microphone module.

- c. Remove the webcam/microphone module **(3)**.

The webcam/microphone module is available using spare part number 781861-001. The microphone module is available using spare part number 730795-001.

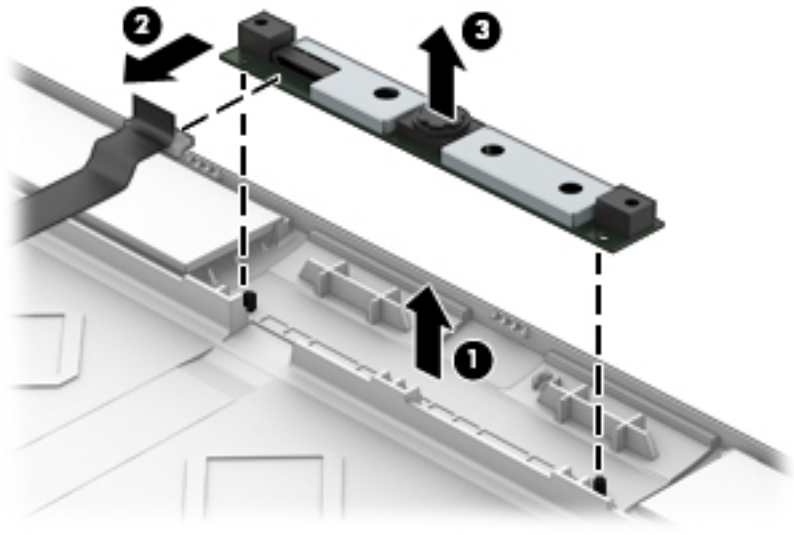

- 8. If it is necessary to replace the display panel cable:

- a. Detach the display panel cable **(1)** from the display enclosure. (The display panel cable is attached to the display enclosure with double-sided adhesive.)
- b. Release the display panel cable from the clip **(2)** built into the display enclosure.
- c. Remove the display panel cable **(3)**.

The display panel cable is included in the Display Cable Kit, spare part number 730537-001, and includes the webcam/microphone module cable.

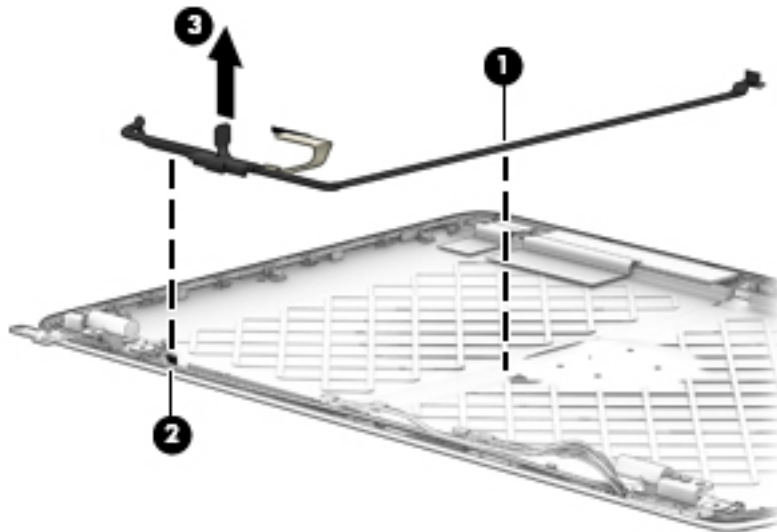

- 9. If it is necessary to replace the display hinges:

- a. Release the grounding tape **(1)** that secures the display hinges to the display enclosure.
- b. Remove the six Phillips PM2.0×3.0 broad head screws **(2)** that secure the display hinges to the display enclosure.

- c. Remove the display hinges (3).

The display hinges are included in the Display Hinge Kits, spare part numbers 775895-001 (for use only on computer models equipped with an FHD display) and 730543-001 (for use only on computer models equipped with an HD display).

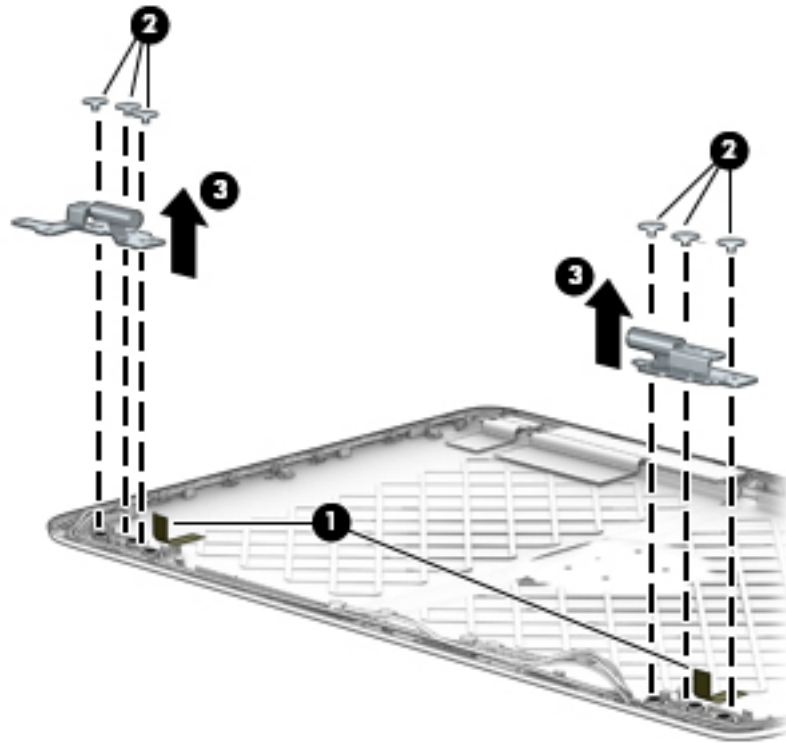

- 10. If it is necessary to replace the WLAN antenna cables and transceivers:
 - a. Detach the WLAN antenna transceivers (1) from the display enclosure. (The WLAN antenna transceivers are attached to the display enclosure with double-sided adhesive.)
 - b. Release the WLAN antenna cables from the clips (2) built into the left and right sides of the display enclosure.

- c. Remove the WLAN antenna cables and transceivers **(3)**.

The WLAN antenna cables and transceivers are included in the Antenna Kits, spare part numbers 781834-001 (for use only on computer models equipped with an HD display) and 781835-001 (for use only on computer models equipped with an FHD display).

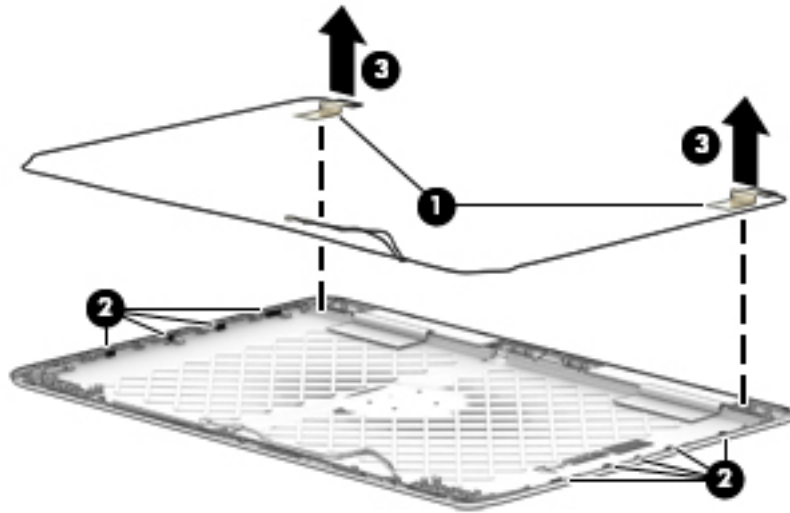

- 11. If it is necessary to replace the WWAN antenna cables and transceivers:

- a. Detach the WWAN antenna transceivers **(1)** from the display enclosure. (The WWAN antenna transceivers are attached to the display enclosure with double-sided adhesive.)
- b. Release the WWAN antenna cables from the clips **(2)** built into the left and right sides of the display enclosure.
- c. Remove the WWAN antenna cables and transceivers **(3)**.

The WWAN antenna cables and transceivers are included in the Antenna Kits, spare part numbers 781834-001 (for use only on computer models equipped with an HD display) and 781835-001 (for use only on computer models equipped with an FHD display).

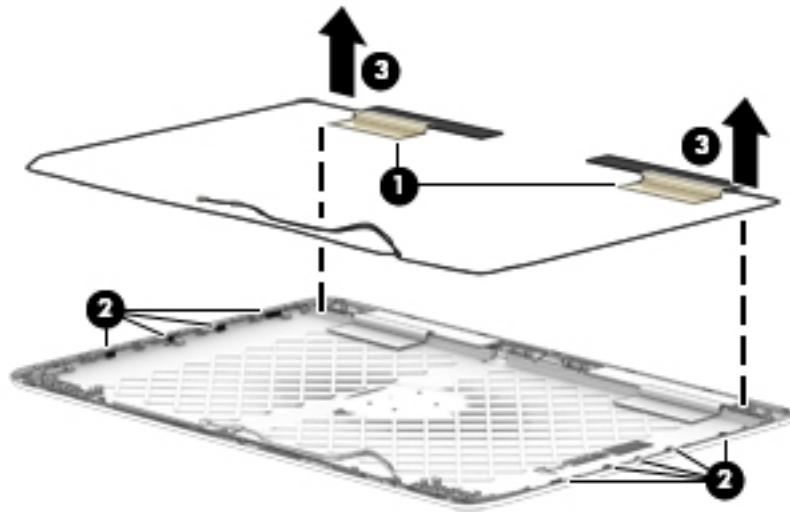

Reverse this procedure to reassemble install the display assembly.

TouchPad

Description	Spare part number
TouchPad for use in models without NFC (includes cable)	781859-001
TouchPad or use in models with NFC; includes NFC antenna and TouchPad cable	781860-001

Before removing the TouchPad, follow these steps:

1. Turn off the computer. If you are unsure whether the computer is off or in Hibernation, turn the computer on, and then shut it down through the operating system.
2. Disconnect the power from the computer by unplugging the power cord from the computer.
3. Disconnect all external devices from the computer.
4. Remove the service cover (see [Service cover on page 46](#)), and then remove the following components:
 - a. Battery (see [Battery on page 48](#))
 - b. Hard drive (see [Hard drive on page 50](#))
 - c. Keyboard (see [Keyboard on page 60](#))
 - d. Top cover (see [Top cover on page 67](#))

Remove the TouchPad:

1. Turn the top cover upside down with the front toward you.
2. Release the ZIF connector **(1)** to which the TouchPad cable is attached, and then disconnect the TouchPad cable from the card reader board.
3. Remove the two Phillips PM2.0×3.25 screws **(2)** that secure the TouchPad to the top cover.
4. Remove the TouchPad and cable **(3)**.

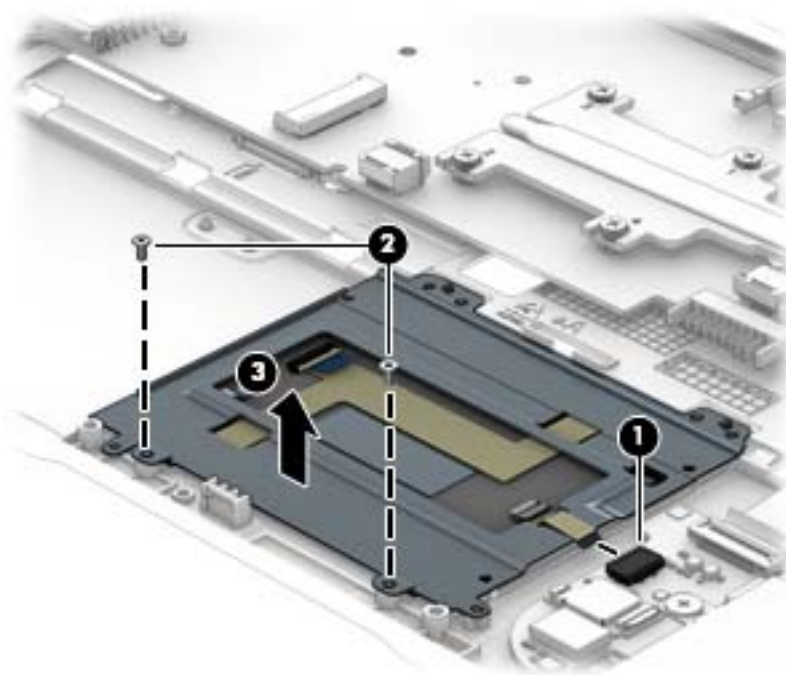

Reverse this procedure to install the TouchPad.

NFC module

Description	Spare part number
NFC module	781862-001

Before removing the NFC module, follow these steps:

1. Turn off the computer. If you are unsure whether the computer is off or in Hibernation, turn the computer on, and then shut it down through the operating system.
2. Disconnect the power from the computer by unplugging the power cord from the computer.
3. Disconnect all external devices from the computer.
4. Remove the service cover (see [Service cover on page 46](#)), and then remove the following components:
 - a. Battery (see [Battery on page 48](#))
 - b. Hard drive (see [Hard drive on page 50](#))
 - c. Keyboard (see [Keyboard on page 60](#))
 - d. Top cover (see [Top cover on page 67](#))

Remove the NFC module:

1. Turn the top cover upside down with the front toward you.
2. Disconnect the bottom cable **(1)** and top cable **(2)** from the NFC module.
3. Remove the NFC module **(3)**.

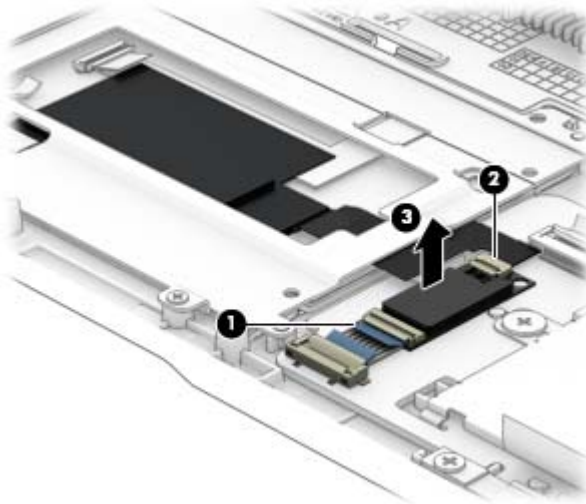

Reverse this procedure to install the NFC module.

Card reader board

Description	Spare part number
Card reader board (includes cable)	781841-001

Before removing the card reader board, follow these steps:

1. Turn off the computer. If you are unsure whether the computer is off or in Hibernation, turn the computer on, and then shut it down through the operating system.
2. Disconnect the power from the computer by unplugging the power cord from the computer.
3. Disconnect all external devices from the computer.
4. Remove the service cover (see [Service cover on page 46](#)), and then remove the following components:
 - a. Battery (see [Battery on page 48](#))
 - b. Hard drive (see [Hard drive on page 50](#))
 - c. Keyboard (see [Keyboard on page 60](#))
 - d. Top cover (see [Top cover on page 67](#))

Remove the card reader board:

1. Turn the top cover upside down with the front toward you.
2. Release the ZIF connector **(1)** to which the card reader board cable is attached, and then disconnect the card reader board cable **(2)** from the system board.

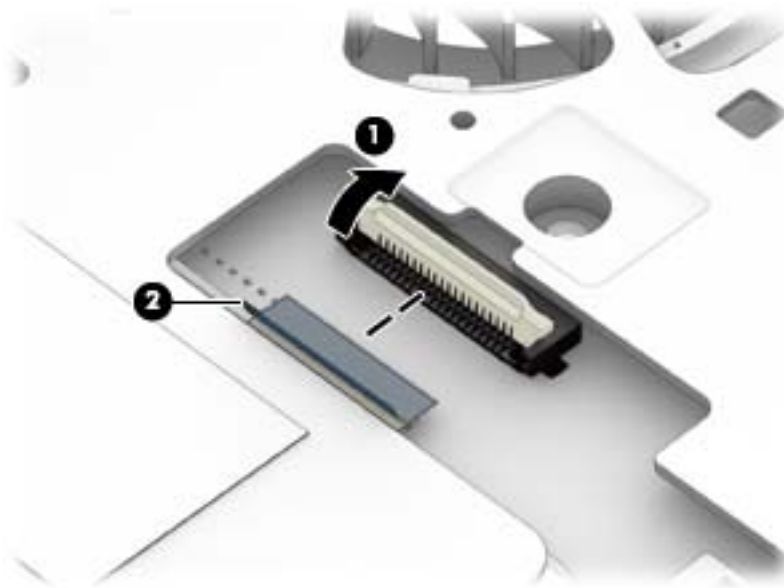

3. Turn the top cover upside down with the front toward you.
4. Release the ZIF connector **(1)** to which the TouchPad cable is attached, and then disconnect the TouchPad cable from the card reader board.
5. Release the card reader board cable **(2)** through the opening in the top cover.

6. Remove the three Phillips PM2.0×2.0 broad head screws **(3)** that secure the card reader board to the top cover.
7. Remove the card reader board and cable **(4)**.

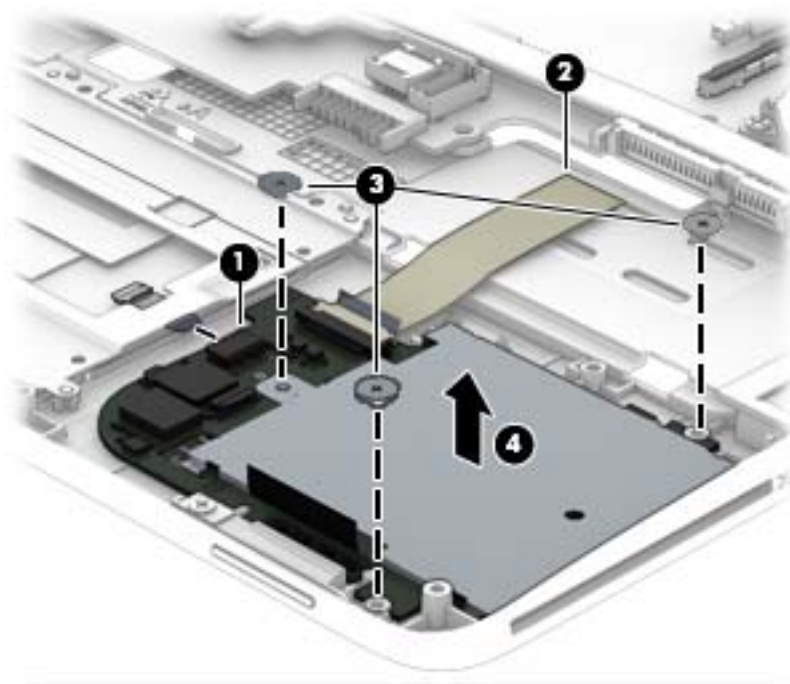

8. Remove the card reader board and cable.
Reverse this procedure to install the card reader board.

Heat sink



NOTE: The heat sink spare part kit includes replacement thermal material.

Description	Spare part number
Heat sink	730556-001

Before removing the heat sink, follow these steps:

1. Turn off the computer. If you are unsure whether the computer is off or in Hibernation, turn the computer on, and then shut it down through the operating system.
2. Disconnect the power from the computer by unplugging the power cord from the computer.
3. Disconnect all external devices from the computer.
4. Remove the service cover (see [Service cover on page 46](#)), and then remove the following components:
 - a. Battery (see [Battery on page 48](#))
 - b. Hard drive (see [Hard drive on page 50](#))
 - c. Keyboard (see [Keyboard on page 60](#))
 - d. Top cover (see [Top cover on page 67](#))

Remove the heat sink:

1. Turn the top cover upside down with the front toward you.
2. Detach the heat sink shroud **(1)** from the fan. (The heat sink shroud is attached to the fan with double-sided adhesive.)
3. Following the 1 through 4 sequence stamped into the heat sink, loosen the four Phillips captive screws **(2)** that secure the heat sink to the system board.

4. Remove the heat sink (3).

 **NOTE:** Due to the adhesive quality of the thermal material located between the heat sink and the system board components, it may be necessary to move the heat sink from side to side to detach it.

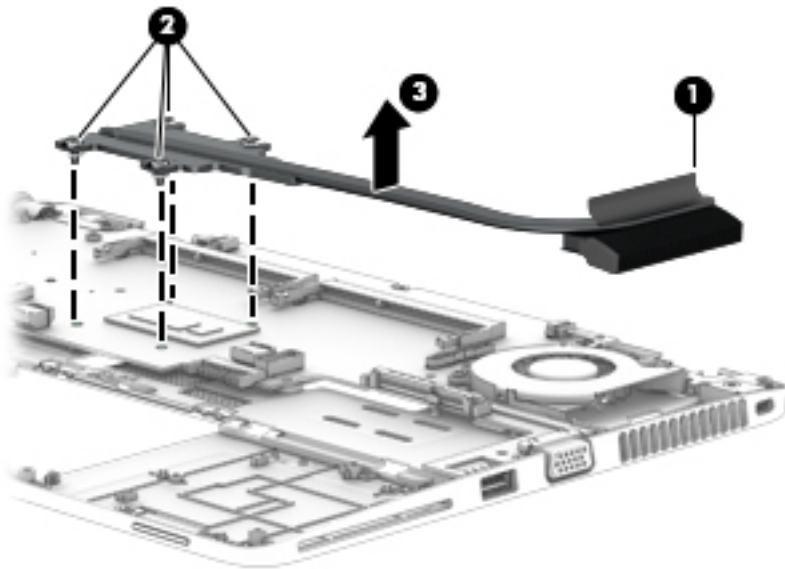

 **NOTE:** The thermal material must be thoroughly cleaned from the surfaces of the heat sink and the system board components each time the heat sink is removed. Replacement thermal material is included with the heat sink and system board spare part kits. Thermal paste is used on the processor (1) and the heat sink section (2) that services it.

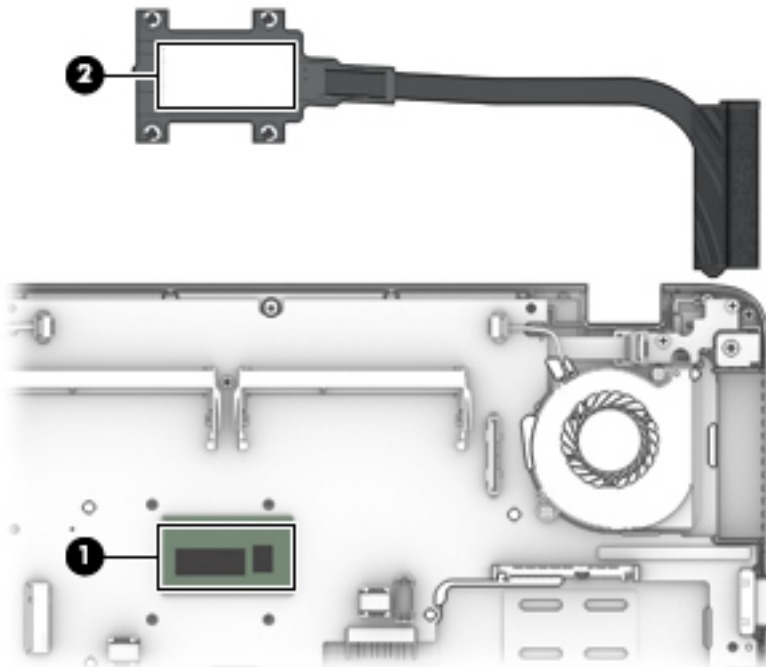

Reverse this procedure to install the heat sink.

Fan

Description	Spare part number
Fan (includes cable)	730547-001

Before removing the fan, follow these steps:

1. Turn off the computer. If you are unsure whether the computer is off or in Hibernation, turn the computer on, and then shut it down through the operating system.
2. Disconnect the power from the computer by unplugging the power cord from the computer.
3. Disconnect all external devices from the computer.
4. Remove the service cover (see [Service cover on page 46](#)), and then remove the following components:
 - a. Battery (see [Battery on page 48](#))
 - b. Hard drive (see [Hard drive on page 50](#))
 - c. Keyboard (see [Keyboard on page 60](#))
 - d. Top cover (see [Top cover on page 67](#))
 - e. Heat sink (see [Heat sink on page 82](#))

Remove the fan:

1. Turn the top cover upside down with the front toward you.
2. Disconnect the fan cable (1) from the system board.
3. Loosen the two Phillips captive screws (2) that secure the fan to the system board.
4. Remove the fan (3).

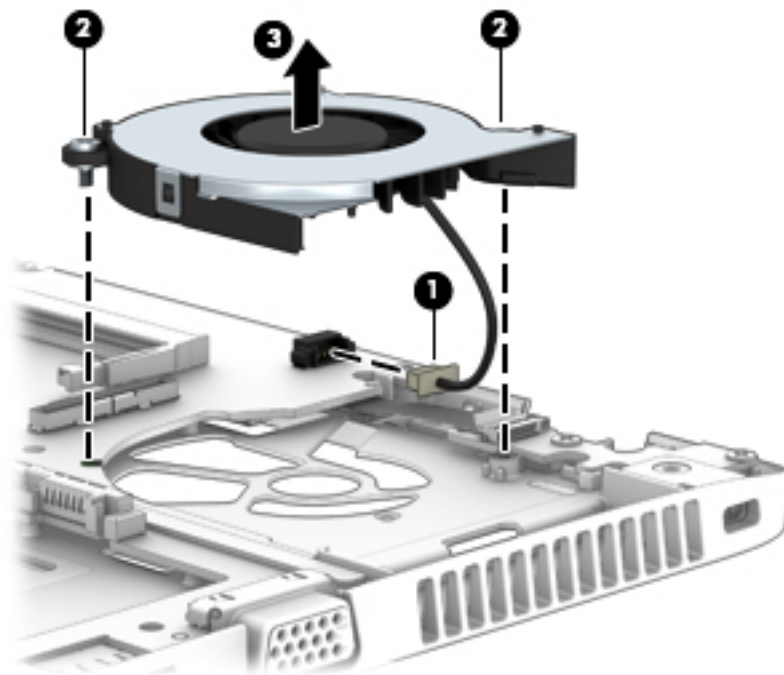

 **NOTE:** The thermal material must be thoroughly cleaned from the surfaces of the heat sink and the system board components each time the heat sink is removed. Replacement thermal material is included with the heat sink and system board spare part kits. Thermal paste is used on the processor **(1)** and the heat sink section **(2)** that services it.

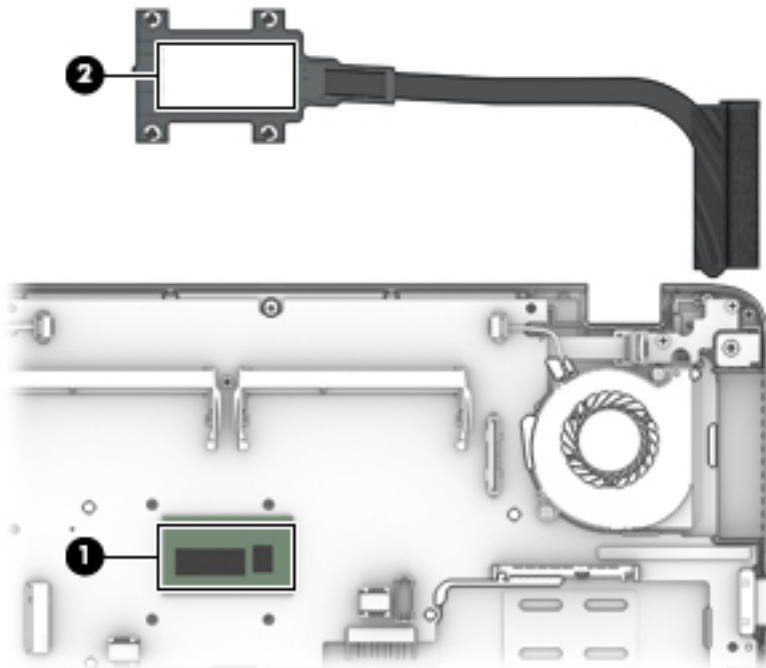

Reverse this procedure to install the fan.

System board



NOTE: The system board spare part kit includes the battery connector bracket and replacement thermal material.

Description	Spare part number
System board for use only on computer models equipped with:	
Intel Core i7-5600U processor and the Windows 8 Professional operating system	781858-601
Intel Core i7-5600U processor and the Windows 8 Standard operating system	781858-501
Intel Core i7-5600U processor and a non-Windows 8 operating system	781858-001
Intel Core i7-5500U processor and the Windows 8 Professional operating system	781857-601
Intel Core i7-5500U processor and the Windows 8 Standard operating system	781857-501
Intel Core i7-5500U processor and a non-Windows 8 operating system	781857-001
Intel Core i5-5300U processor and the Windows 8 Professional operating system	781856-601
Intel Core i5-5300U processor and the Windows 8 Standard operating system	781856-501
Intel Core i5-5300U processor and a non-Windows 8 operating system	781856-001
Intel Core i5-5200U processor and the Windows 8 Professional operating system	781855-601
Intel Core i5-5200U processor and the Windows 8 Standard operating system	781855-501
Intel Core i5-5200U processor and a non-Windows 8 operating system	781855-001
Intel Core i3-5010U processor and the Windows 8 Professional operating system	781854-601
Intel Core i3-5010U processor and the Windows 8 Standard operating system	781854-501
Intel Core i3-5010U processor and a non-Windows 8 operating system	781854-001

Before removing the system board, follow these steps:

1. Turn off the computer. If you are unsure whether the computer is off or in Hibernation, turn the computer on, and then shut it down through the operating system.
2. Disconnect the power from the computer by unplugging the power cord from the computer.
3. Disconnect all external devices from the computer.
4. Remove the service cover (see [Service cover on page 46](#)), and then remove the following components:
 - a. Battery (see [Battery on page 48](#))
 - b. Hard drive (see [Hard drive on page 50](#))
 - c. Keyboard (see [Keyboard on page 60](#))
 - d. RTC battery (see [RTC battery on page 66](#))
 - e. Top cover (see [Top cover on page 67](#))
 - f. Heat sink (see [Heat sink on page 82](#))
 - g. Fan (see [Fan on page 84](#))

 **NOTE:** When replacing the system board, be sure that the following components are removed from the defective system board and installed on the replacement system board:

- WWAN module (see [WWAN module on page 53](#))
- Solid-state drive (see [Solid-state drive on page 55](#))
- WLAN module (see [WLAN module on page 57](#))
- Memory modules (see [Memory module on page 59](#))

Remove the system board:

1. Turn the top cover upside down with the front toward you.
2. Release the ZIF connector **(1)** to which the power button board cable is attached, and then disconnect the power button board cable from the system board.
3. Release the ZIF connector **(2)** to which the fingerprint reader board cable is attached, and then disconnect the fingerprint reader board cable from the system board.

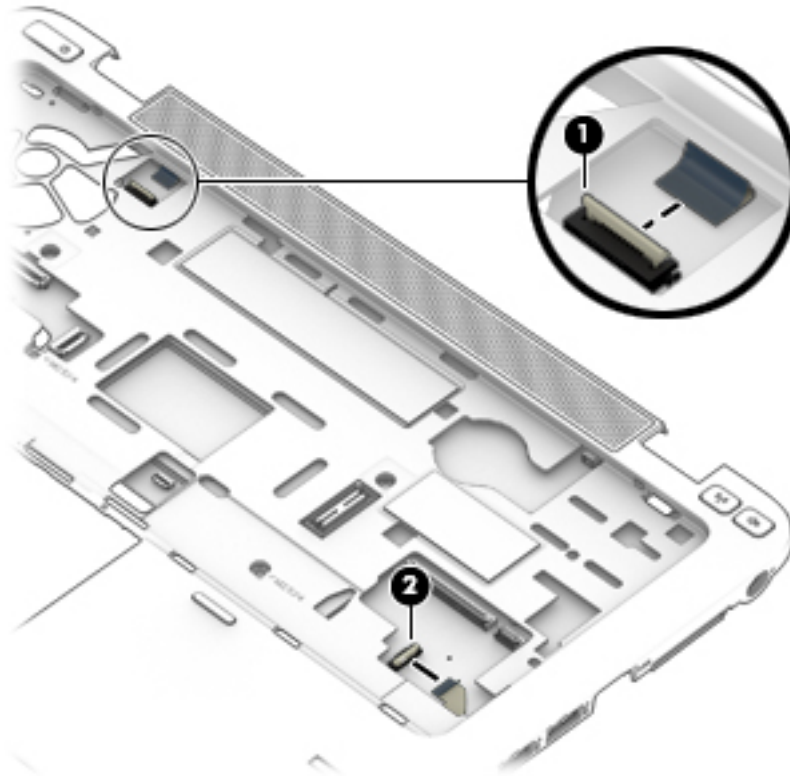

4. Disconnect the speaker cable **(1)** from the system board.

5. Remove the three Phillips PM2.0×3.0 screws (2) that secure the system board to the top cover.

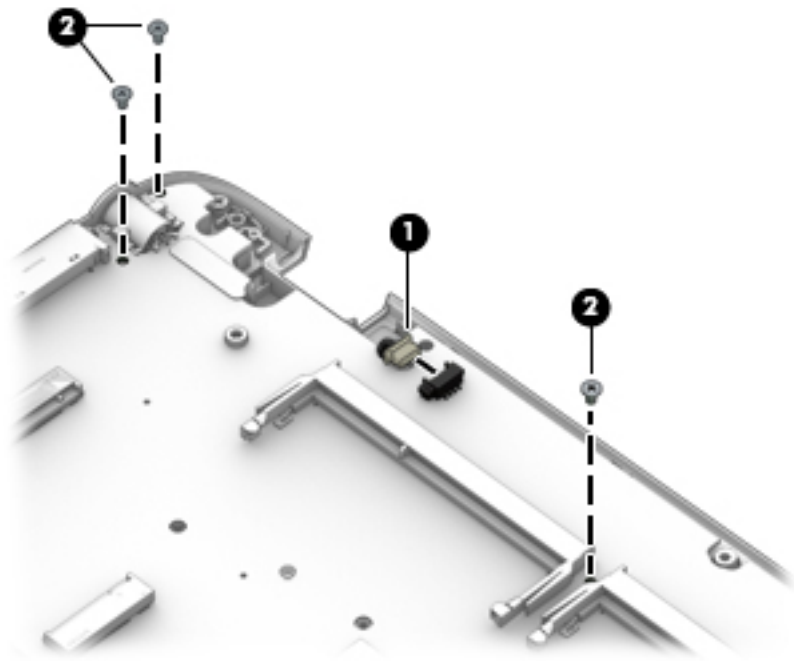

6. Lift up on the right side of the system board (1) until it rests at an angle.
7. Remove the system board (2) by sliding it up and to the right at an angle.

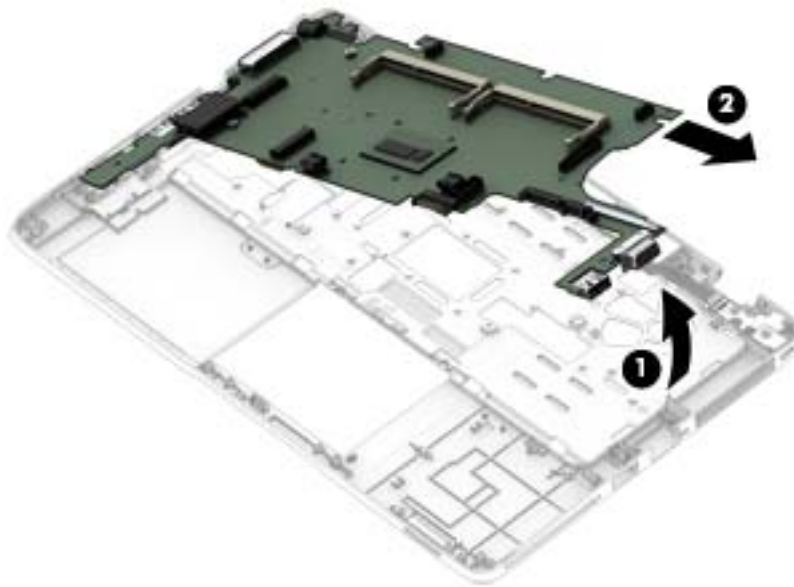

Reverse this procedure to install the system board.

Fingerprint reader board

Description	Spare part number
Fingerprint reader board (includes bracket and cable)	730554-001

Before removing the fingerprint reader board, follow these steps:

1. Turn off the computer. If you are unsure whether the computer is off or in Hibernation, turn the computer on, and then shut it down through the operating system.
2. Disconnect the power from the computer by unplugging the power cord from the computer.
3. Disconnect all external devices from the computer.
4. Remove the service cover (see [Service cover on page 46](#)), and then remove the following components:
 - a. Battery (see [Battery on page 48](#))
 - b. Hard drive (see [Hard drive on page 50](#))
 - c. Keyboard (see [Keyboard on page 60](#))
 - d. Top cover (see [Top cover on page 67](#))

Remove the fingerprint reader board:

1. Turn the top cover upside down with the front toward you.
2. Detach the fingerprint reader board cable **(1)** from the top cover. (The fingerprint reader board cable is attached to the top cover with double-sided adhesive.)
3. Remove the three Phillips PM2.0×2.5 screws that secure the fingerprint reader board and bracket to the top cover.
4. Remove the fingerprint reader board bracket **(3)**.

5. Remove the fingerprint reader board (4).

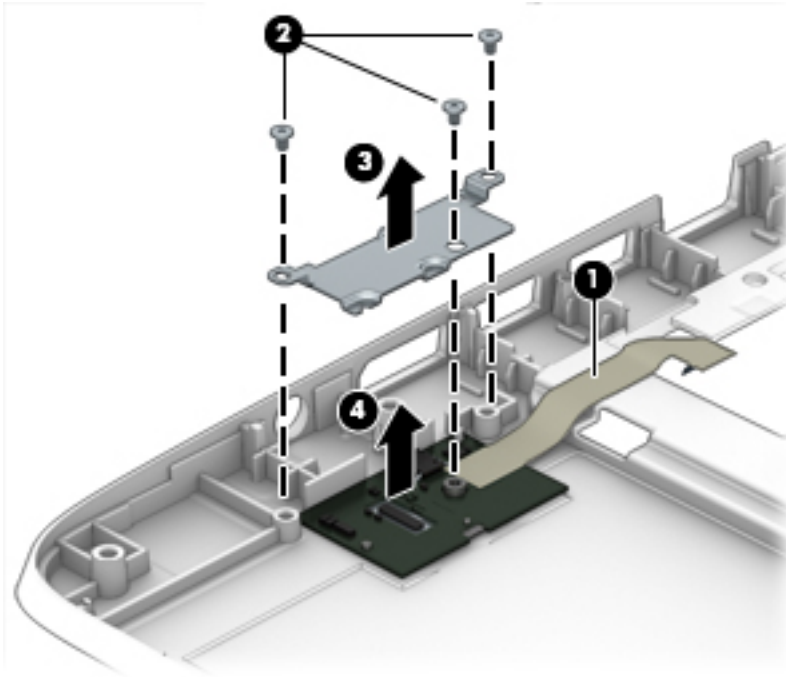

Reverse this procedure to install the fingerprint reader board.

Speaker assembly

Description	Spare part number
Speaker assembly (includes left and right speakers and cables)	730555-001

Before removing the speaker assembly, follow these steps:

1. Turn off the computer. If you are unsure whether the computer is off or in Hibernation, turn the computer on, and then shut it down through the operating system.
2. Disconnect the power from the computer by unplugging the power cord from the computer.
3. Disconnect all external devices from the computer.
4. Remove the service cover (see [Service cover on page 46](#)), and then remove the following components:
 - a. Battery (see [Battery on page 48](#))
 - b. Hard drive (see [Hard drive on page 50](#))
 - c. Keyboard (see [Keyboard on page 60](#))
 - d. Top cover (see [Top cover on page 67](#))
 - e. System board (see [System board on page 86](#))

Remove the speaker assembly:

1. Release the four clips (1) built into the top cover that secure the speaker assembly to the top cover.

2. Remove the speaker assembly (2).

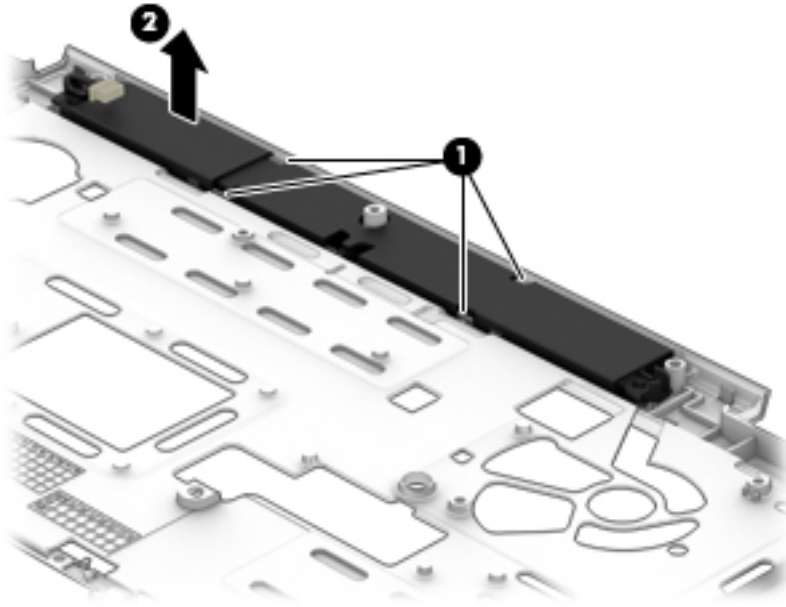

Reverse this procedure to install the speaker assembly.

Power button board

Description	Spare part number
Power button board (includes cable)	730552-001

Before removing the power button board, follow these steps:

1. Turn off the computer. If you are unsure whether the computer is off or in Hibernation, turn the computer on, and then shut it down through the operating system.
2. Disconnect the power from the computer by unplugging the power cord from the computer.
3. Disconnect all external devices from the computer.
4. Remove the service cover (see [Service cover on page 46](#)), and then remove the following components:
 - a. Battery (see [Battery on page 48](#))
 - b. Hard drive (see [Hard drive on page 50](#))
 - c. Keyboard (see [Keyboard on page 60](#))
 - d. Top cover (see [Top cover on page 67](#))
 - e. System board (see [System board on page 86](#))

Remove the power button board:

1. Remove the two Phillips PM2.0×3.25 screws (1) that secure the power button board to the top cover.
2. Remove the power button board (2) and cable.

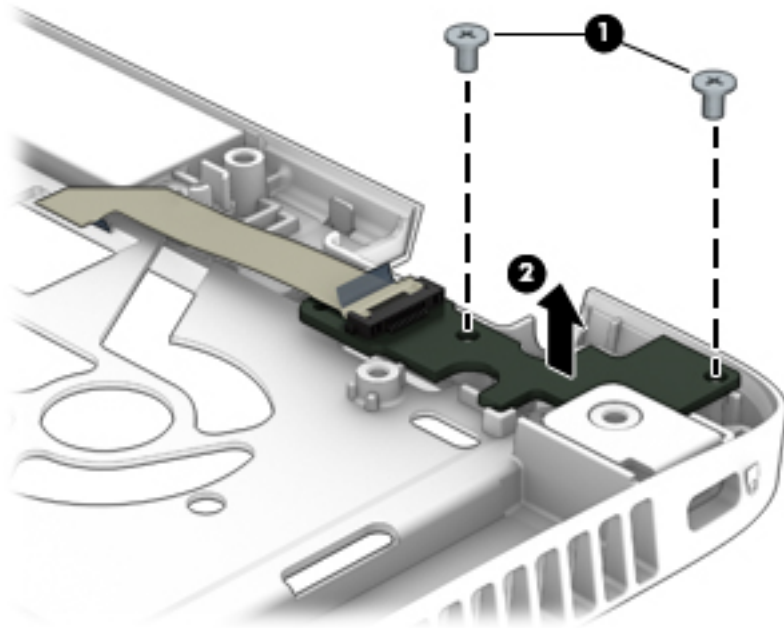

Reverse this procedure to install the power button board.

7 Computer Setup (BIOS), MultiBoot, and HP PC Hardware Diagnostics (UEFI) in Windows 8.1

Using Computer Setup

Computer Setup, or Basic Input/Output System (BIOS), controls communication between all the input and output devices on the system (such as disk drives, display, keyboard, mouse, and printer). Computer Setup includes settings for the types of devices installed, the startup sequence of the computer, and the amount of system and extended memory.

 **NOTE:** Use extreme care when making changes in Computer Setup. Errors can prevent the computer from operating properly.

Starting Computer Setup

 **NOTE:** An external keyboard or mouse connected to a USB port can be used with Computer Setup only if USB legacy support is enabled.

To start Computer Setup, follow these steps:

1. Turn on or restart the computer, and then press **esc** while the “Press the ESC key for Startup Menu” message is displayed at the bottom of the screen.
2. Press **f10** to enter Computer Setup.

Navigating and selecting in Computer Setup

To navigate and select in Computer Setup, follow these steps:

1. Turn on or restart the computer, and then press **esc** while the “Press the ESC key for Startup Menu” message is displayed at the bottom of the screen.

 **NOTE:** You can use either a pointing device (TouchPad, pointing stick, or USB mouse) or the keyboard to navigate and make selections in Computer Setup.

2. Press **f10** to enter Computer Setup.
 - To select a menu or a menu item, use the **tab** key and the keyboard arrow keys and then press **enter**, or use a pointing device to click the item.
 - To scroll up and down, click the up arrow or the down arrow in the upper-right corner of the screen, or use the up arrow key or the down arrow key on the keyboard.
 - To close open dialog boxes and return to the main Computer Setup screen, press **esc**, and then follow the on-screen instructions.

To exit Computer Setup menus, choose one of the following methods:

- To exit Computer Setup menus without saving your changes:
Click the **Exit** icon in the lower-right corner of the screen, and then follow the on-screen instructions.

– or –

Use the arrow keys to select **Main > Ignore Changes and Exit**, and then press [enter](#).

- To save your changes and exit Computer Setup menus:

Click the **Save** icon in the lower-right corner of the screen, and then follow the on-screen instructions.

– or –

Use the arrow keys to select **Main > Save Changes and Exit**, and then press [enter](#).

Your changes go into effect when the computer restarts.

Restoring factory settings in Computer Setup



NOTE: Restoring defaults will not change the hard drive mode.

To return all settings in Computer Setup to the values that were set at the factory, follow these steps:

1. Turn on or restart the computer, and then press [esc](#) while the “Press the ESC key for Startup Menu” message is displayed at the bottom of the screen.
2. Press [f10](#) to enter Computer Setup.
3. Use a pointing device or the arrow keys to select **Main > Restore Defaults**.
4. Follow the on-screen instructions.
5. To save your changes and exit, click the **Save** icon in the lower-right corner of the screen, and then follow the on-screen instructions.

– or –

Use the arrow keys to select **Main > Save Changes and Exit**, and then press [enter](#).

Your changes go into effect when the computer restarts.



NOTE: Your password settings and security settings are not changed when you restore the factory settings.

Updating the BIOS

Updated versions of the BIOS may be available on the HP website.

Most BIOS updates on the HP website are packaged in compressed files called *SoftPaqs*.

Some download packages contain a file named *Readme.txt*, which contains information regarding installing and troubleshooting the file.

Determining the BIOS version

To determine whether available BIOS updates contain later BIOS versions than those currently installed on the computer, you need to know the version of the system BIOS currently installed.

BIOS version information (also known as *ROM date* and *System BIOS*) can be revealed by pressing **fn+esc** (if you are already in Windows) or by using Computer Setup.

1. Start Computer Setup.
2. Use a pointing device or the arrow keys to select **Main > System Information**.
3. To exit Computer Setup without saving your changes, click the **Exit** icon in the lower-right corner of the screen, and then follow the on-screen instructions.

– or –

Use the arrow keys to select **Main > Ignore Changes and Exit**, and then press [enter](#).

Downloading a BIOS update

 **CAUTION:** To reduce the risk of damage to the computer or an unsuccessful installation, download and install a BIOS update only when the computer is connected to reliable external power using the AC adapter. Do not download or install a BIOS update while the computer is running on battery power, docked in an optional docking device, or connected to an optional power source. During the download and installation, follow these instructions:

Do not disconnect power on the computer by unplugging the power cord from the AC outlet.

Do not shut down the computer or initiate Sleep.

Do not insert, remove, connect, or disconnect any device, cable, or cord.

1. From the Start screen, type `support`, and then select the HP Support Assistant app.
2. Click **Updates and tune-ups**, and then click **Check for HP updates now**.
3. Follow the on-screen instructions.
4. At the download area, follow these steps:
 - a. Identify the most recent BIOS update and compare it to the BIOS version currently installed on your computer. Make a note of the date, name, or other identifier. You may need this information to locate the update later, after it has been downloaded to your hard drive.
 - b. Follow the on-screen instructions to download your selection to the hard drive.

If the update is more recent than your BIOS, make a note of the path to the location on your hard drive where the BIOS update is downloaded. You will need to access this path when you are ready to install the update.

 **NOTE:** If you connect your computer to a network, consult the network administrator before installing any software updates, especially system BIOS updates.

BIOS installation procedures vary. Follow any instructions that are revealed on the screen after the download is complete. If no instructions are revealed, follow these steps:

1. From the Start screen, type `file`, and then select **File Explorer**.
2. Click your hard drive designation. The hard drive designation is typically Local Disk (C:).
3. Using the hard drive path you recorded earlier, open the folder on your hard drive that contains the update.
4. Double-click the file that has an `.exe` extension (for example, `filename.exe`).
The BIOS installation begins.
5. Complete the installation by following the on-screen instructions.



NOTE: After a message on the screen reports a successful installation, you can delete the downloaded file from your hard drive.

Using MultiBoot

About the boot device order

As the computer starts, the system attempts to boot from enabled devices. The MultiBoot utility, which is enabled at the factory, controls the order in which the system selects a boot device. Boot devices can include optical drives, diskette drives, a network interface card (NIC), hard drives, and USB devices. Boot devices contain bootable media or files that the computer needs to start and operate properly.



NOTE: Some boot devices must be enabled in Computer Setup before they can be included in the boot order.

You can change the order in which the computer searches for a boot device by changing the boot order in Computer Setup. You can also press `esc` while the “Press the ESC key for Startup Menu” message is displayed at the bottom of the screen, and then press `f9`. Pressing `f9` displays a menu that shows the current boot devices and allows you to select a boot device. Or, you can use MultiBoot Express to set the computer to prompt you for a boot location each time the computer turns on or restarts.

Choosing MultiBoot preferences

You can use MultiBoot in the following ways:

- To set a new boot order that the computer uses each time it is turned on, by changing the boot order in Computer Setup.
- To dynamically choose the boot device, by pressing `esc` while the “Press the ESC key for Startup Menu” message is displayed at the bottom of the screen, and then pressing `f9` to enter the Boot Device Options menu.
- To use MultiBoot Express to set variable boot orders. This feature prompts you for a boot device each time the computer is turned on or restarted.

Setting a new boot order in Computer Setup

To start Computer Setup and set a boot device order that the computer uses each time it is turned on or restarted, follow these steps:

1. Turn on or restart the computer, and then press **esc** while the “Press the ESC key for Startup Menu” message is displayed at the bottom of the screen.
2. Press **f10** to enter Computer Setup.
3. Use a pointing device or the arrow keys to select one of the following options:
 - **Advanced > Boot Options > UEFI Boot Order > UEFI Hybrid**
 - **Advanced > Boot Options > UEFI Boot Order > UEFI Native Boot mode**
 - **Advanced > Boot Options > Legacy Boot Order > Legacy Boot Mode**Press **enter**.
4. To move the device up in the boot order, use a pointing device to click the up arrow, or press the **+** key.
– or –
To move the device down in the boot order, use a pointing device to click the down arrow, or press the **-** key.
5. To save your changes and exit Computer Setup, click the **Save** icon in the lower-left corner of the screen, and then follow the on-screen instructions.
– or –
Use the arrow keys to select **Main > Save Changes and Exit**, and then press **enter**.

Dynamically choosing a boot device using the f9 prompt

To dynamically choose a boot device for the current startup sequence, follow these steps:

1. Open the Select Boot Device menu by turning on or restarting the computer, and then pressing **esc** while the “Press the ESC key for Startup Menu” message is displayed at the bottom of the screen.
2. Press **f9**.
3. Use a pointing device or the arrow keys to select a boot device, then press **enter**.

Setting a MultiBoot Express prompt

To start Computer Setup and set the computer to display the MultiBoot startup location menu each time the computer is started or restarted, follow these steps:

1. Turn on or restart the computer, and then press **esc** while the “Press the ESC key for Startup Menu” message is displayed at the bottom of the screen.
2. Press **f10** to enter Computer Setup.
3. Use a pointing device or the arrow keys to select **Advanced > Boot Options > MultiBoot Express Boot Popup Delay (Sec)**, and then press **enter**.
4. In the **MultiBoot Express Popup Delay (Sec)** field, enter the length of time in seconds that you want the computer to display the startup location menu before it defaults to the current MultiBoot setting. (When 0 is selected, the Express Boot startup location menu is not displayed.)
5. To save your changes and exit Computer Setup, click the **Save** icon in the lower-left corner of the screen, and then follow the on-screen instructions.
– or –
Use the arrow keys to select **Main > Save Changes and Exit**, and then press **enter**.

Your changes go into effect when the computer restarts.

Entering MultiBoot Express preferences

When the Express Boot menu is displayed during startup, you have the following choices:

- To specify a boot device from the Express Boot menu, select your preference within the allotted time, and then press **enter**.
- To prevent the computer from defaulting to the current MultiBoot setting, press any key before the allotted time expires. The computer will not start until you select a boot device and press **enter**.
- To allow the computer to start according to the current MultiBoot settings, wait for the allotted time to expire.

Using HP PC Hardware Diagnostics (UEFI)

HP PC Hardware Diagnostics is a Unified Extensible Firmware Interface (UEFI) that allows you to run diagnostic tests to determine whether the computer hardware is functioning properly. The tool runs outside the operating system so that it can isolate hardware failures from issues that are caused by the operating system or other software components.

To start HP PC Hardware Diagnostics UEFI:

1. Turn on or restart the computer, quickly press **esc**, and then press **f2**.

The BIOS searches three places for the diagnostic tools, in the following order:

- a. Connected USB drive



NOTE: To download the HP PC Hardware Diagnostics (UEFI) tool to a USB drive, see [Downloading HP PC Hardware Diagnostics \(UEFI\) to a USB device on page 98](#).

- b. Hard drive
- c. BIOS

2. When the diagnostic tool opens, use the keyboard arrow keys to select the type of diagnostic test you want to run, and then follow the on-screen instructions.



NOTE: If you need to stop a diagnostic test, press **esc**.

Downloading HP PC Hardware Diagnostics (UEFI) to a USB device



NOTE: Instructions for downloading HP PC Hardware Diagnostics (UEFI) are provided in English only.

There are two options to download HP PC Hardware Diagnostics to a USB device:

Option 1: HP PC Diagnostics homepage— Provides access to the latest UEFI version

1. Go to <http://hp.com/go/techcenter/pcdiags>.
2. Click the **UEFI Download** link, and then select **Run**.

Option 2: Support and Drivers page—Provides downloads for a specific product for earlier and later versions

1. Go to <http://www.hp.com>.
2. Point to **Support**, located at the top of the page, and then click **Download Drivers**.

3. In the text box, enter the product name, and then click **Go**.

– or –

Click **Find Now** to let HP automatically detect your product.

4. Select your computer model, and then select your operating system.

5. In the **Diagnostic** section, click **HP UEFI Support Environment**.

– or –

Click **Download**, and then select **Run**.

Using HP Sure Start (select models only)

Select computer models are configured with HP Sure Start, a technology that continuously monitors the computer's BIOS for attacks or corruption. If the BIOS becomes corrupted or is attacked, HP Sure Start automatically restores the BIOS to its previously safe state, without user intervention.

HP Sure Start is configured and already enabled so that most users can use the HP Sure Start default configuration. The default configuration can be customized by advanced users.

To access the latest documentation on HP Sure Start, go to <http://www.hp.com/support>, and select your country. Select **Drivers & Downloads**, and then follow the on-screen instructions.

8 Computer Setup (BIOS), MultiBoot, and HP PC Hardware Diagnostics (UEFI) in Windows 7

Using Computer Setup

Computer Setup, or Basic Input/Output System (BIOS), controls communication between all the input and output devices on the system (such as disk drives, display, keyboard, mouse, and printer). Computer Setup includes settings for the types of devices installed, the startup sequence of the computer, and the amount of system and extended memory.

 **NOTE:** Use extreme care when making changes in Computer Setup. Errors can prevent the computer from operating properly.

Starting Computer Setup

 **NOTE:** An external keyboard or mouse connected to a USB port can be used with Computer Setup only if USB legacy support is enabled.

To start Computer Setup, follow these steps:

1. Turn on or restart the computer, and then press **esc** while the “Press the ESC key for Startup Menu” message is displayed at the bottom of the screen.
2. Press **f10** to enter Computer Setup.

Navigating and selecting in Computer Setup

To navigate and select in Computer Setup, follow these steps:

1. Turn on or restart the computer, and then press **esc** while the “Press the ESC key for Startup Menu” message is displayed at the bottom of the screen.

 **NOTE:** You can use either a pointing device (TouchPad, pointing stick, or USB mouse) or the keyboard to navigate and make selections in Computer Setup.

2. Press **f10** to enter Computer Setup.
 - To select a menu or a menu item, use the **tab** key and the keyboard arrow keys and then press **enter**, or use a pointing device to click the item.
 - To scroll up and down, click the up arrow or the down arrow in the upper-right corner of the screen, or use the up arrow key or the down arrow key on the keyboard.
 - To close open dialog boxes and return to the main Computer Setup screen, press **esc**, and then follow the on-screen instructions.

To exit Computer Setup menus, choose one of the following methods:

- To exit Computer Setup menus without saving your changes:
Click the **Exit** icon in the lower-right corner of the screen, and then follow the on-screen instructions.

– or –

Use the arrow keys to select **Main > Ignore Changes and Exit**, and then press [enter](#).

- To save your changes and exit Computer Setup menus:

Click the **Save** icon in the lower-right corner of the screen, and then follow the on-screen instructions.

– or –

Use the arrow keys to select **Main > Save Changes and Exit**, and then press [enter](#).

Your changes go into effect when the computer restarts.

Restoring factory settings in Computer Setup



NOTE: Restoring defaults will not change the hard drive mode.

To return all settings in Computer Setup to the values that were set at the factory, follow these steps:

1. Turn on or restart the computer, and then press [esc](#) while the “Press the ESC key for Startup Menu” message is displayed at the bottom of the screen.
2. Press [f10](#) to enter Computer Setup.
3. Use a pointing device or the arrow keys to select **Main > Restore Defaults**.
4. Follow the on-screen instructions.
5. To save your changes and exit, click the **Save** icon in the lower-right corner of the screen, and then follow the on-screen instructions.

– or –

Use the arrow keys to select **Main > Save Changes and Exit**, and then press [enter](#).

Your changes go into effect when the computer restarts.



NOTE: Your password settings and security settings are not changed when you restore the factory settings.

Updating the BIOS

Updated versions of the BIOS may be available on the HP website.

Most BIOS updates on the HP website are packaged in compressed files called *SoftPaqs*.

Some download packages contain a file named *Readme.txt*, which contains information regarding installing and troubleshooting the file.

Determining the BIOS version

To determine whether available BIOS updates contain later BIOS versions than those currently installed on the computer, you need to know the version of the system BIOS currently installed.

BIOS version information (also known as *ROM date* and *System BIOS*) can be revealed by pressing [fn+esc](#) (if you are already in Windows) or by using Computer Setup.

1. Start Computer Setup.
2. Use a pointing device or the arrow keys to select **Main > System Information**.
3. To exit Computer Setup without saving your changes, click the **Exit** icon in the lower-right corner of the screen, and then follow the on-screen instructions.

– or –

Use the arrow keys to select **Main > Ignore Changes and Exit**, and then press [enter](#).

Downloading a BIOS update

 **CAUTION:** To reduce the risk of damage to the computer or an unsuccessful installation, download and install a BIOS update only when the computer is connected to reliable external power using the AC adapter. Do not download or install a BIOS update while the computer is running on battery power, docked in an optional docking device, or connected to an optional power source. During the download and installation, follow these instructions:

Do not disconnect power on the computer by unplugging the power cord from the AC outlet.

Do not shut down the computer or initiate Sleep.

Do not insert, remove, connect, or disconnect any device, cable, or cord.

1. Access Help and Support by selecting **Start > Help and Support**.
2. Select **Updates and tune-ups**, and then select **Check for HP updates now**.
3. At the download area, follow these steps:
 - a. Identify the most recent BIOS update and compare it to the BIOS version currently installed on your computer. Make a note of the date, name, or other identifier. You may need this information to locate the update later, after it has been downloaded to your hard drive.
 - b. Follow the on-screen instructions to download your selection to the hard drive.

If the update is more recent than your BIOS, make a note of the path to the location on your hard drive where the BIOS update is downloaded. You will need to access this path when you are ready to install the update.

 **NOTE:** If you connect your computer to a network, consult the network administrator before installing any software updates, especially system BIOS updates.

BIOS installation procedures vary. Follow any instructions that are revealed on the screen after the download is complete. If no instructions are revealed, follow these steps:

1. Select **Start > Computer**.
2. Click your hard drive designation. The hard drive designation is typically Local Disk (C:).
3. Using the hard drive path you recorded earlier, open the folder on your hard drive that contains the update.
4. Double-click the file that has an .exe extension (for example, *filename.exe*).

The BIOS installation begins.
5. Complete the installation by following the on-screen instructions.

 **NOTE:** After a message on the screen reports a successful installation, you can delete the downloaded file from your hard drive.

Using MultiBoot

About the boot device order

As the computer starts, the system attempts to boot from enabled devices. The MultiBoot utility, which is enabled at the factory, controls the order in which the system selects a boot device. Boot devices can include optical drives, diskette drives, a network interface card (NIC), hard drives, and USB devices. Boot devices contain bootable media or files that the computer needs to start and operate properly.



NOTE: Some boot devices must be enabled in Computer Setup before they can be included in the boot order.

You can change the order in which the computer searches for a boot device by changing the boot order in Computer Setup. You can also press **esc** while the “Press the ESC key for Startup Menu” message is displayed at the bottom of the screen, and then press **f9**. Pressing **f9** displays a menu that shows the current boot devices and allows you to select a boot device. Or, you can use MultiBoot Express to set the computer to prompt you for a boot location each time the computer turns on or restarts.

Choosing MultiBoot preferences

You can use MultiBoot in the following ways:

- To set a new boot order that the computer uses each time it is turned on, by changing the boot order in Computer Setup.
- To dynamically choose the boot device, by pressing **esc** while the “Press the ESC key for Startup Menu” message is displayed at the bottom of the screen, and then pressing **f9** to enter the Boot Device Options menu.
- To use MultiBoot Express to set variable boot orders. This feature prompts you for a boot device each time the computer is turned on or restarted.

Setting a new boot order in Computer Setup

To start Computer Setup and set a boot device order that the computer uses each time it is turned on or restarted, follow these steps:

1. Turn on or restart the computer, and then press **esc** while the “Press the ESC key for Startup Menu” message is displayed at the bottom of the screen.
2. Press **f10** to enter Computer Setup.
3. Use a pointing device or the arrow keys to select the **Legacy Boot Order** list, and then press **enter**.
4. To move the device up in the boot order, use a pointing device to click the up arrow, or press the **+** key.
– or –
To move the device down in the boot order, use a pointing device to click the down arrow, or press the **-** key.
5. To save your changes and exit Computer Setup, click the **Save** icon in the lower-left corner of the screen, and then follow the on-screen instructions.
– or –
Use the arrow keys to select **Main > Save Changes and Exit**, and then press **enter**.

Dynamically choosing a boot device using the f9 prompt

To dynamically choose a boot device for the current startup sequence, follow these steps:

1. Open the Select Boot Device menu by turning on or restarting the computer, and then pressing **esc** while the “Press the ESC key for Startup Menu” message is displayed at the bottom of the screen.
2. Press **f9**.
3. Use a pointing device or the arrow keys to select a boot device, then press **enter**.

Setting a MultiBoot Express prompt

To start Computer Setup and set the computer to display the MultiBoot startup location menu each time the computer is started or restarted, follow these steps:

1. Turn on or restart the computer, and then press **esc** while the “Press the ESC key for Startup Menu” message is displayed at the bottom of the screen.
2. Press **f10** to enter Computer Setup.
3. Use a pointing device or the arrow keys to select **System Configuration > Boot Options**, and then press **enter**.
4. In the **MultiBoot Express Popup Delay (Sec)** field, enter the length of time in seconds that you want the computer to display the startup location menu before it defaults to the current MultiBoot setting. (When 0 is selected, the Express Boot startup location menu is not displayed.)
5. To save your changes and exit Computer Setup, click the **Save** icon in the lower-left corner of the screen, and then follow the on-screen instructions.

– or –

Use the arrow keys to select **Main > Save Changes and Exit**, and then press **enter**.

Your changes go into effect when the computer restarts.

Entering MultiBoot Express preferences

When the Express Boot menu is displayed during startup, you have the following choices:

- To specify a boot device from the Express Boot menu, select your preference within the allotted time, and then press **enter**.
- To prevent the computer from defaulting to the current MultiBoot setting, press any key before the allotted time expires. The computer will not start until you select a boot device and press **enter**.
- To allow the computer to start according to the current MultiBoot settings, wait for the allotted time to expire.

Using HP PC Hardware Diagnostics (UEFI) (select models only)

HP PC Hardware Diagnostics is a Unified Extensible Firmware Interface (UEFI) that allows you to run diagnostic tests to determine if the computer hardware is functioning properly. The tool runs outside of the operating system to isolate hardware failures from issues that may be caused by the operating system or other software components.

To start HP PC Hardware Diagnostics UEFI:

1. Turn on or restart the computer, quickly press [esc](#), and then press [f2](#).

After pressing [f2](#), the BIOS searches three places for the HP PC Hardware Diagnostics (UEFI) tools in the following order:

- a. Connected USB drive



NOTE: To download the HP PC Hardware Diagnostics (UEFI) tool to a USB drive, see [Downloading HP PC Hardware Diagnostics \(UEFI\) to a USB device on page 105](#).

- b. Hard drive

- c. BIOS

2. Use the keyboard arrow keys to select the type of diagnostic test you want to run, and then follow the on-screen instructions.



NOTE: If you need to stop a diagnostic test while it is running, press [esc](#).

Downloading HP PC Hardware Diagnostics (UEFI) to a USB device



NOTE: The HP PC Hardware Diagnostics (UEFI) download instructions are provided in English only.

There are two options to download HP PC Hardware Diagnostics to a USB device:

Option 1: HP PC Diagnostics homepage— Provides access to the latest UEFI version

1. Go to <http://hp.com/go/techcenter/pcdiags>.
2. Click the **UEFI Download** link, and then select **Run**.

Option 2: Support and Drivers page—Provides downloads for a specific product for earlier and later versions

1. Go to <http://www.hp.com>.
2. Point to **Support**, located at the top of the page, and then click **Download Drivers**.
3. In the text box, enter the product name, and then click **Go**.

– or –

Click **Find Now** to let HP automatically detect your product.

4. Select your computer model, and then select your operating system.
5. In the Diagnostic section, click **HP UEFI Support Environment**.

– or –

Click **Download**, and then select **Run**.

9 Specifications

	Metric	U.S.
Dimensions		
Width	31.0 cm	12.2 in
Depth	21.5 cm	8.5 in
Height	2.1 cm	0.83 in
Weight		
Equipped with 3-cell (26 Whr) battery, FHD, no fingerprint reader, 1 SODIMM, WLAN, lightest M.2 SSD primary storage module, no camera, no WWAN, non-touch	1.36 kg	2.99 lb
Equipped with 3-cell (26 Whr) battery, FHD, no fingerprint reader, 1 SODIMM, WLAN, lightest M.2 SSD primary storage module, no camera, no WWAN, touch	1.52 kg	3.35 lb
Equipped with 3-cell (46 Whr) battery, FHD, no fingerprint reader, 1 SODIMM, WLAN, lightest M.2 SSD primary storage module, no camera, no WWAN, non-touch	1.47 kg	3.25 lb
Equipped with 3-cell (46 Whr) battery, FHD, no fingerprint reader, 1 SODIMM, WLAN, lightest M.2 SSD primary storage module, no camera, no WWAN, touch	1.61 kg	3.55 lb
Input power		
Operating voltage and current	19.5 V dc @ 2.31 A - 45 W	
	19.5 V dc @ 3.33 A - 65 W	
Temperature		
Operating	5°C to 35°C	41°F to 95°F
Nonoperating	-20°C to 60°C	-4°F to 140°F
Relative humidity (non-condensing)		
Operating	10% to 90%	
Nonoperating	5% to 95%	
Maximum altitude (unpressurized)		
Operating	-15 m to 3,048 m	-50 ft to 10,000 ft
Nonoperating	-15 m to 12,192 m	-50 ft to 40,000 ft
NOTE: Applicable product safety standards specify thermal limits for plastic surfaces. The device operates well within this range of temperatures.		

10 Backup and recovery in Windows 8.1

To protect your information, use Windows backup and restore utilities to back up individual files and folders, back up your entire hard drive, create system repair media (select models only) by using the installed optical drive (select models only) or an optional external optical drive, or create system restore points. In case of system failure, you can use the backup files to restore the contents of your computer.

From the Start screen, type `restore`, click **Settings**, and then select from the list of displayed options.

 **NOTE:** For detailed instructions on various backup and restore options, perform a search for these topics in Windows Help and Support.

In case of system instability, HP recommends that you print the recovery procedures and save them for later use.

 **NOTE:** Windows includes the User Account Control feature to improve the security of your computer. You may be prompted for your permission or password for tasks such as installing software, running utilities, or changing Windows settings. For more information, see Windows Help and Support.

Backing up your information

Recovery after a system failure is as good as your most recent backup. You should create system repair media and your initial backup immediately after initial system setup. As you add new software and data files, you should continue to back up your system on a regular basis to maintain a reasonably current backup.

For more information on the Windows backup features, see Windows Help and Support.

Performing a system recovery

In case of system failure or instability, the computer provides the following tools to recover your files:

- **Windows recovery tools:** You can use Windows Backup and Restore to recover information you have previously backed up. You can also use Windows Automatic Repair to fix problems that might prevent Windows from starting correctly.
- **f11 recovery tools:** You can use the [f11](#) recovery tools to recover your original hard drive image. The image includes the Windows operating system and software programs installed at the factory.

 **NOTE:** If you are unable to boot (start up) your computer and you cannot use the system repair media you previously created (select models only), you must purchase Windows operating system media to reboot the computer and repair the operating system. For additional information, see [Using Windows operating system media \(purchased separately\) on page 109](#).

Using the Windows recovery tools

To recover information you previously backed up, see Windows Help and Support for steps on restoring files and folders.

To recover your information using Automatic Repair, follow these steps:

 **CAUTION:** Some Startup Repair options will completely erase and reformat the hard drive. All files you have created and any software installed on the computer are permanently removed. When reformatting is complete, the recovery process restores the operating system, as well as the drivers, software, and utilities from the backup used for recovery.

1. If possible, back up all personal files.
2. If possible, check for the presence of the Recovery Image partition and the Windows partition.

From the Start screen, type `file`, and then click **File Explorer**.

– or –

From the Start screen, type `pc`, and then select **This PC**.

 **NOTE:** If the Windows partition and the Recovery Image partition are not listed, you must recover your operating system and programs using the Windows operating system DVD and the *Driver Recovery* media (both purchased separately). For additional information, see [Using Windows operating system media \(purchased separately\) on page 109](#).

3. If the Windows partition and the Recovery Image partition are listed, restart the computer by pressing and holding the `shift` key while clicking **Restart**.
4. Select **Troubleshoot**, then select **Advanced Options**, and then select **Startup Repair**.
5. Follow the on-screen instructions.

 **NOTE:** For additional information on recovering information using the Windows tools, perform a search for these topics in Windows Help and Support.

Using f11 recovery tools

 **CAUTION:** Using `f11` completely erases hard drive contents and reformats the hard drive. All files that you have created and any software that you have installed on the computer are permanently removed. The `f11` recovery tool reinstalls the operating system and HP programs and drivers that were installed at the factory. Software not installed at the factory must be reinstalled.

To recover the original hard drive image using `f11`:

1. If possible, back up all personal files.
2. If possible, check for the presence of the Recovery Image partition: From the Start screen, type `pc`, and then select **This PC**.

 **NOTE:** If the Recovery Image partition is not listed, you must recover your operating system and programs using the Windows operating system media and the *Driver Recovery* media (both purchased separately). For additional information, see [Using Windows operating system media \(purchased separately\) on page 109](#).

3. If the Recovery Image partition is listed, restart the computer, and then press `esc` while the “Press the ESC key for Startup Menu” message is displayed at the bottom of the screen.
4. Press `f11` while the “Press <F11> for recovery” message is displayed on the screen.
5. Follow the on-screen instructions.

Using Windows operating system media (purchased separately)

To order a Windows operating system DVD, contact support. See the *Worldwide Telephone Numbers* booklet included with the computer. You can also find contact information from the HP website. Go to <http://www.hp.com/support>, select your country or region, and follow the on-screen instructions.

 **CAUTION:** Using a Windows operating system media completely erases hard drive contents and reformats the hard drive. All files that you have created and any software that you have installed on the computer are permanently removed. When reformatting is complete, the recovery process helps you restore the operating system, as well as drivers, software, and utilities.

To initiate a full install of the operating system using a Windows operating system DVD:

 **NOTE:** This process takes several minutes.

1. If possible, back up all personal files.
2. Insert the Windows operating system DVD into the optical drive, and then restart the computer.
3. When prompted, press any keyboard key.
4. Follow the on-screen instructions.

After the installation is completed:

1. Eject the Windows operating system media and then insert the *Driver Recovery* media.
2. Install the Hardware Enabling Drivers first, and then install Recommended Applications.

Using Windows Refresh or Windows Reset

When your computer is not working properly and you need to regain system stability, the Windows Refresh option allows you to start fresh and keep what is important to you.

The Windows Reset option allows you to perform detailed reformatting of your computer, or remove personal information before you give away or recycle your computer. For more information on these features, see Windows Help and Support.

Using HP Software Setup

HP Software Setup can be used to reinstall drivers or select software that has been corrupted or deleted from the system.

1. From the Start screen, type `HP Software Setup`.
2. Open HP Software Setup.
3. Follow the on-screen directions to reinstall drivers or select software.

11 Backup and recovery in Windows 7

Your computer includes HP and Windows tools to help you safeguard your information and retrieve it if you ever need to. These tools will help you return your computer to a proper working state, all with simple steps. This section provides information about the following processes:

- Creating recovery media and backups
- Restoring and recovering your system

Creating recovery media and backups

Recovery after a system failure is only as good as your most recent backup.

1. After you successfully set up the computer, create HP Recovery media. This step creates a Windows 7 operating system DVD and a *Driver Recovery* DVD. The Windows DVD can be used to reinstall the original operating system in cases where the hard drive is corrupted or has been replaced. The *Driver Recovery* DVD installs specific drivers and applications. See [Creating recovery media with HP Recovery Disc Creator on page 110](#).
2. Use Windows Backup and Recovery tools to perform the following:
 - Back up individual files and folders
 - Back up your entire hard drive (select models only)
 - Create system repair discs (select models only) with the installed optical drive (select models only) or an optional external optical drive
 - Create system restore points

 **NOTE:** This guide describes an overview of backing up, restoring, and recovering options. For more details about the tools provided, see Help and Support. To access Help and Support, select **Start > Help and Support**.

 **NOTE:** HP recommends that you print the recovery procedures and save them for later use, in case of system instability.

In case of system failure, you can use the backup files to restore the contents of your computer. See [Backing up your information on page 111](#).

Guidelines

- When creating recovery media or backing up to discs, use any of the following types of discs (purchased separately): DVD+R, DVD+R DL, DVD-R, DVD-R DL, or DVD±RW. The discs you use will depend on the type of optical drive you are using.
- Be sure that the computer is connected to AC power before you start the recovery media creation process or the backup process.

Creating recovery media with HP Recovery Disc Creator

HP Recovery Disc Creator is a software program that offers an alternative way to create recovery media. After you successfully set up the computer, you can create recovery media using HP Recovery Disc Creator. This recovery media allows you to reinstall your original operating system as well as select drivers and

applications if the hard drive becomes corrupted. HP Recovery Disc Creator can create two kinds of recovery DVDs:

- Windows 7 operating system DVD—Installs the operating system without additional drivers or applications.
- *Driver Recovery* DVD—Installs specific drivers and applications only, in the same way that the HP Software Setup utility installs drivers and applications.

Creating recovery media

 **NOTE:** The Windows 7 operating system DVD can be created only once. Thereafter, the option to create that media will not be available after you create a Windows DVD.

To create the Windows DVD:

1. Select **Start > All Programs > Productivity and Tools > HP Recovery Disc Creator**.
2. Select **Windows disk**.
3. From the drop-down menu, select the drive for burning the recovery media.
4. Click the **Create** button to start the burning process.

After the Windows 7 operating system DVD has been created, create the *Driver Recovery* DVD:

1. Select **Start > All Programs > Productivity and Tools > HP Recovery Disc Creator**.
2. Select **Driver disk**.
3. From the drop-down menu, select the drive for burning the recovery media.
4. Click the **Create** button to start the burning process.

Backing up your information

You should create system repair media and your initial backup immediately after initial system setup. As you add new software and data files, you should continue to back up your system on a regular basis to maintain a reasonably current backup. You should also create Windows system repair media (select models only) which can be used to start up (boot) the computer and repair the operating system in case of system instability or failure. Your initial and subsequent backups allow you to restore your data and settings if a failure occurs.

You can back up your information to an optional external hard drive, a network drive, or discs.

Note the following when backing up:

- Store personal files in the Documents library, and back it up regularly.
- Back up templates that are stored in their associated directories.
- Save customized settings that appear in a window, toolbar, or menu bar by taking a screen shot of your settings. The screen shot can be a time-saver if you have to reset your preferences.
- When backing up to discs, number each disc after removing it from the drive.

 **NOTE:** For detailed instructions on various backup and restore options, perform a search for these topics in Help and Support. To access Help and Support, select **Start > Help and Support**.

 **NOTE:** Windows includes the User Account Control feature to improve the security of your computer. You may be prompted for your permission or password for tasks such as installing software, running utilities, or changing Windows settings. Refer to Help and Support. To access Help and Support, select **Start > Help and Support**.

To create a backup using Windows Backup and Restore:



NOTE: The backup process may take over an hour, depending on file size and the speed of the computer.

1. Select **Start > All Programs > Maintenance > Backup and Restore**.
2. Follow the on-screen instructions to set up your backup, create a system image (select models only), or create system repair media (select models only).

Performing a system recovery

In case of system failure or instability, the computer provides the following tools to recover your files:

- Windows recovery tools: You can use Windows Backup and Restore to recover information you have previously backed up. You can also use Windows Startup Repair to fix problems that might prevent Windows from starting correctly.
- f11 recovery tools (select models only): You can use the f11 recovery tools to recover your original hard drive image. The image includes the Windows operating system and software programs installed at the factory.



NOTE: If you are unable to boot (start up) your computer and you cannot use the system repair media you previously created (select models only), you must purchase Windows 7 operating system media to reboot the computer and repair the operating system. For additional information, see [Using Windows 7 operating system media on page 113](#).

Using the Windows recovery tools

Using the Windows recovery tools, you can:

- Recover individual files
- Restore the computer to a previous system restore point
- Recover information using recovery tools



NOTE: For detailed instructions on various recovery and restore options, perform a search for these topics in Help and Support. To access Help and Support, select **Start > Help and Support**.



NOTE: Windows includes the User Account Control feature to improve the security of your computer. You may be prompted for your permission or password for tasks such as installing software, running utilities, or changing Windows settings. Refer to Help and Support. To access Help and Support, select **Start > Help and Support**.

To recover information you previously backed up:

1. Select **Start > All Programs > Maintenance > Backup and Restore**.
2. Follow the on-screen instructions to recover your system settings, your computer (select models only), or your files.

To recover your information using Startup Repair, follow these steps:



CAUTION: Some Startup Repair options will completely erase and reformat the hard drive. All files you have created and any software installed on the computer are permanently removed. When reformatting is complete, the recovery process restores the operating system, as well as the drivers, software, and utilities from the backup used for recovery.

1. If possible, back up all personal files.
2. If possible, check for the presence of the Windows partition.

To check for the Windows partition, select **Start > Computer**.



NOTE: If the Windows partition is not listed, you must recover your operating system and programs using the Windows 7 operating system DVD and the *Driver Recovery* media. For additional information, see [Using Windows 7 operating system media on page 113](#).

3. If the Windows partition is listed, restart the computer, and then press **f8** before the Windows operating system loads.
4. Select **Startup Repair**.
5. Follow the on-screen instructions.



NOTE: For additional information on recovering information using the Windows tools, select **Start > Help and Support**.

Using f11 recovery tools (select models only)



CAUTION: Using **f11** completely erases hard drive contents and reformats the hard drive. All files that you have created and any software that you have installed on the computer are permanently removed. The **f11** recovery tool reinstalls the operating system and HP programs and drivers that were installed at the factory. Software not installed at the factory must be reinstalled.

To recover the original hard drive image using **f11**:

1. If possible, back up all personal files.
2. If possible, check for the presence of the HP Recovery partition: click **Start**, right-click **Computer**, click **Manage**, and then click **Disk Management**.



NOTE: If the HP Recovery partition is not listed, you must recover your operating system and programs using the Windows 7 operating system media and the *Driver Recovery* media. For additional information, see [Using Windows 7 operating system media on page 113](#).

3. If the HP Recovery partition is listed, restart the computer, and then press **esc** while the “Press the ESC key for Startup Menu” message is displayed at the bottom of the screen.
4. Press **f11** while the “Press <F11> for recovery” message is displayed on the screen.
5. Follow the on-screen instructions.

Using Windows 7 operating system media

If you cannot use the recovery media you previously created using the HP Recovery Disc Creator (select models only), you must purchase a Windows 7 operating system DVD to reboot the computer and repair the operating system.

To order a Windows 7 operating system DVD, go to the HP website. For U.S. support, go to <http://www.hp.com/support>. For worldwide support, go to http://welcome.hp.com/country/us/en/wwcontact_us.html. You can also order the DVD by calling support. For contact information, see the *Worldwide Telephone Numbers* booklet included with the computer.



CAUTION: Using a Windows 7 operating system DVD completely erases hard drive contents and reformats the hard drive. All files that you have created and any software that you have installed on the computer are permanently removed. When reformatting is complete, the recovery process helps you restore the operating system, as well as drivers, software, and utilities.

To initiate recovery using a Windows 7 operating system DVD:



NOTE: This process takes several minutes.

1. If possible, back up all personal files.
2. Restart the computer, and then insert the Windows 7 operating system DVD into the optical drive before the Windows operating system loads.
3. When prompted, press any keyboard key.
4. Follow the on-screen instructions.
5. Click **Next**.
6. Select **Repair your computer**.
7. Follow the on-screen instructions.

After the repair is completed:

1. Eject the Windows 7 operating system DVD and then insert the *Driver Recovery* DVD.
2. Install the Hardware Enabling Drivers first, and then install Recommended Applications.

12 Statement of memory volatility

The purpose of this chapter is to provide general information regarding nonvolatile memory in HP Business PCs. This chapter also provides general instructions for restoring nonvolatile memory that can contain personal data after the system has been powered off and the hard drive has been removed.

HP Business PC products that use Intel®-based or AMD®-based system boards contain volatile DDR memory. The amount of nonvolatile memory present in the system depends upon the system configuration. Intel-based and AMD-based system boards contain nonvolatile memory subcomponents as originally shipped from HP, assuming that no subsequent modifications have been made to the system and assuming that no applications, features, or functionality have been added to or installed on the system.

Following system shutdown and removal of all power sources from an HP Business PC system, personal data can remain on volatile system memory (DIMMs) for a finite period of time and will also remain in nonvolatile memory. Use the steps below to remove personal data from the PC, including the nonvolatile memory found in Intel-based and AMD-based system boards.

1. Follow steps (a) through (j) below to restore the nonvolatile memory that can contain personal data. Restoring or reprogramming nonvolatile memory that does not store personal data is neither necessary nor recommended.

- a. Turn on or restart the computer, and then press **esc** while the "Press the ESC key for Startup Menu" message is displayed at the bottom of the screen.



NOTE: If the system has a BIOS administrator password, enter the password at the prompt.

- b. Select **Main**, select **Restore Defaults**, and then select **Yes** to load defaults.
- c. Select the **Security** menu, select **Restore Security Level Defaults**, and then select **Yes** to restore security level defaults.
- d. If an asset or ownership tag is set, select the **Security** menu and scroll down to the **Utilities** menu. Select **System IDs**, and then select **Asset Tracking Number**. Clear the tag, and then make the selection to return to the prior menu.
- e. If a DriveLock password is set, select the **Security** menu, and scroll down to **Hard Drive Tools** under the **Utilities** menu. Select **Hard Drive Tools**, select **DriveLock**, then uncheck the checkbox for **DriveLock password on restart**. Select **OK** to proceed.
- f. If an Automatic DriveLock password is set, select the **Security** menu, scroll down to **Hard Drive Tools** under the **Utilities** menu. Select **Hard Drive Tools**, scroll down to **Automatic DriveLock**, then select the desired hard drive and disable protection. At the automatic drive lock warning screen, select **Yes** to continue. Repeat this procedure if more than one hard drive has an Automatic DriveLock password.
- g. Select the **Main** menu, and then select **Reset BIOS Security to factory default**. Click **Yes** at the warning message.
- h. Select the **Main** menu, select **Save Changes and Exit**, select **Yes** to save changes and exit, and then select **Shutdown**.

- i. Reboot the system. If the system has a Trusted Platform Module (TPM) and/or fingerprint reader, one or two prompts will appear—one to clear the TPM and the other to Reset Fingerprint Sensor; press or tap **F1** to accept or **F2** to reject.
 - j. Remove all power and system batteries for at least 24 hours.
2. Complete one of the following:
- Remove and retain the storage drive.
 - or –
 - Clear the drive contents by using a third party utility designed to erase data from an SSD.
 - or –
 - Clear the contents of the drive by using the following BIOS Setup Secure Erase command option steps:



IMPORTANT: If you clear data using Secure Erase, it cannot be recovered.

- a. Turn on or restart the computer, and then press **esc** while the "Press the ESC key for Startup Menu" message is displayed at the bottom of the screen.
 - b. Select the **Security** menu and scroll down to the **Utilities** menu.
 - c. Select **Hard Drive Tools**.
 - d. Under **Utilities**, select **Secure Erase**, select the hard drive storing the data you want to clear, and then follow the on-screen instructions to continue.
- or –
- Clear the contents of the drive by using the following Disk Sanitizer command steps:



IMPORTANT: If you clear data using Disk Sanitizer, it cannot be recovered.



NOTE: The amount of time it takes for Disk Sanitizer to run can take several hours. Plug the computer into an AC outlet before starting.

- a. Turn on or restart the computer, and then press **esc** while the "Press the ESC key for Startup Menu" message is displayed at the bottom of the screen.
- b. Select the **Security** menu and scroll down to the **Utilities** menu.
- c. Select **Hard Drive Tools**.
- d. Under **Utilities**, select **Disk Sanitizer**, select the hard drive storing the data you want to clear, and then follow the on-screen instructions to continue.

Nonvolatile memory usage

Nonvolatile Memory Type	Amount (Size)	Does this memory store customer data?	Does this memory retain data when power is removed?	What is the purpose of this memory?	How is data input into this memory?	How is this memory write-protected?
HP Sure Start flash (select models only)	2 MBytes	No	Yes	Provides protected backup of critical System BIOS code, EC firmware, and critical PC configuration data for select platforms that support HP Sure Start. For more information, see Using HP Sure Start (select models only) on page 120.	Data cannot be written to this device via the host processor. The content is managed solely by the HP Sure Start Embedded Controller.	This memory is protected by the HP Sure Start Embedded Controller.
Real Time Clock (RTC) battery backed-up CMOS configuration memory	256 Bytes	No	Yes	Stores system date and time and noncritical data.	RTC battery backed-up CMOS is programmed using the Computer Setup (BIOS), or changing the Microsoft Windows date & time.	This memory is not write-protected.
Controller (NIC) EEPROM	64 KBytes (not customer accessible)	No	Yes	Stores NIC configuration and NIC firmware.	NIC EEPROM is programmed using a utility from the NIC vendor that can be run from DOS.	A utility is required to write data to this memory and is available from the NIC vendor. Writing data to this ROM in an inappropriate manner will render the NIC non-functional.
DIMM Serial Presence Detect (SPD) configuration data	256 Bytes per memory module, 128 Bytes programmable (not customer accessible)	No	Yes	Stores memory module information.	DIMM SPD is programmed by the memory vendor.	Data cannot be written to this memory when the module is installed in a PC. The specific write-protection method varies by memory vendor.
System BIOS	4 MBytes to 5 MBytes	Yes	Yes	Stores system BIOS code and PC configuration data.	System BIOS code is programmed at the factory. Code is updated when the system BIOS is updated. Configuration data and settings are input using the Computer Setup (BIOS) or a custom utility.	NOTE: Writing data to this ROM in an inappropriate manner can render the PC non-functional. A utility is required for writing data to this memory and is available on the HP website; go to http://www.hp.com/support , and select your country. Select Drivers &

Nonvolatile Memory Type	Amount (Size)	Does this memory store customer data?	Does this memory retain data when power is removed?	What is the purpose of this memory?	How is data input into this memory?	How is this memory write-protected?
Intel Management Engine Firmware (present in only specific ZBook and EliteBook models. For more information, go to http://www.hp.com/support , and select your country. Select Drivers & Downloads , and then follow the on-screen instructions.)	1.5 MBytes or 5 MBytes	Yes	Yes	Stores Management Engine Code, Settings, Provisioning Data and iAMT third-party data store.	Management Engine Code is programmed at the factory. Code is updated via Intel secure firmware update utility. Unique Provisioning Data can be entered at the factory or by an administrator using the Management Engine (MEBx) setup utility. The third party data store contents can be populated by a remote management console or local applications that have been registered by an administrator to have access to the space.	Downloads , and then follow the on-screen instructions. The Intel chipset is configured to enforce hardware protection to block all direct read/write access to this area. An Intel utility is required for updating the firmware. Only firmware updates digitally signed by Intel can be applied using this utility.
Bluetooth flash	2 Mbit	No	Yes	Stores Bluetooth configuration and firmware.	Bluetooth flash is programmed at the factory. Tools for writing data to this memory are not publicly available but can be obtained from the silicon vendor.	A utility is required for writing data to this memory and is made available through newer versions of the driver whenever the flash requires an upgrade.
802.11 WLAN EEPROM	4 Kbit to 8 Kbit	No	Yes	Stores configuration and calibration data.	802.11 WLAN EEPROM is programmed at the factory. Tools for writing data to this memory are not made public.	A utility is required for writing data to this memory and is typically not made available to the public unless a firmware upgrade is necessary to address a unique issue.
Web camera	64 Kbit	No	Yes	Stores webcam configuration and firmware.	Webcam memory is programmed using a utility from the device manufacturer that can be run from Windows.	A utility is required for writing data to this memory and is typically not made available to the public unless a firmware upgrade is necessary to address a unique issue.
Fingerprint reader	512 KByte flash	Yes	Yes	Stores fingerprint templates.	Fingerprint reader memory is programmed by user enrollment in HP ProtectTools Security Manager.	Only a digitally signed application can make the call to write to the flash.

Questions and answers

1. How can the BIOS settings be restored (returned to factory settings)?



IMPORTANT: Restore defaults does not securely erase any data on your hard drive. See question and answer 6 for steps to securely erase data.

Restore defaults does not reset the Custom Secure Boot keys. See question and answer 7 for information about resetting the keys.

- a. Turn on or restart the computer, and then press **esc** while the "Press the ESC key for Startup Menu" message is displayed at the bottom of the screen.
- b. Select **Main**, and then select **Restore defaults**.
- c. Follow the on-screen instructions.
- d. Select **Main**, select **Save Changes and Exit**, and then follow the on-screen instructions.

2. What is a UEFI BIOS, and how is it different from a legacy BIOS?

The Unified Extensible Firmware Interface (UEFI) BIOS is an industry-standard software interface between the platform firmware and an operating system (OS). It is a replacement for the older BIOS architecture, but supports much of the legacy BIOS functionality.

Like the legacy BIOS, the UEFI BIOS provides an interface to display the system information and configuration settings and to change the configuration of your computer before an OS is loaded. BIOS provides a secure run-time environment that supports a Graphic User Interface (GUI). In this environment, you can use either a pointing device (Touchscreen, TouchPad, pointing stick, or USB mouse) or the keyboard to navigate and make menu and configuration selections. The UEFI BIOS also contains basic system diagnostics.

The UEFI BIOS provides functionality beyond that of the legacy BIOS. In addition, the UEFI BIOS works to initialize the computer's hardware before loading and executing the OS; the run-time environment allows the loading and execution of software programs from storage devices to provide more functionality, such as advanced hardware diagnostics (with the ability to display more detailed system information) and advanced firmware management and recovery software.

HP has provided options in Computer Setup (BIOS) to allow you to run in legacy BIOS, if required by the operating system. Examples of this requirement would be if you upgrade or downgrade the OS.

3. Where does the UEFI BIOS reside?

The UEFI BIOS resides on a flash memory chip. A utility is required to write to the chip.

4. What kind of configuration data is stored on the DIMM Serial Presence Detect (SPD) memory module? How would this data be written?

The DIMM SPD memory contains information about the memory module, such as size, serial number, data width, speed/timing, voltage, and thermal information. This information is written by the module manufacturer and stored on an EEPROM. This EEPROM cannot be written to when the memory module is installed in a PC. Third-party tools do exist that can write to the EEPROM when the memory module is not installed in a PC. Various third-party tools are available to read SPD memory.

5. What is meant by "Restore the nonvolatile memory found in Intel-based system boards"?

This message relates to clearing the Real Time Clock (RTC) CMOS memory that contains PC configuration data.

6. How can the BIOS security be reset to factory defaults and data erased?

 **IMPORTANT:** Resetting will result in the loss of information.

These steps will not reset Custom Secure Boot Keys. See question and answer 7 for information about resetting the keys.

- a. Turn on or restart the computer, and then press **esc** while the "Press the ESC key for Startup Menu" message is displayed at the bottom of the screen.
- b. Select **Main**, and then select **Reset BIOS Security to Factory Default**.
- c. Follow the on-screen instructions.
- d. Select **Main**, select **Save Changes and Exit**, and then follow the on-screen instructions.

7. How can the Custom Secure Boot Keys be reset?

Secure Boot is a feature to ensure that only authenticated code can start on a platform. If you enabled Secure Boot and created Custom Secure Boot Keys, simply disabling Secure Boot will not clear the keys. You must also select to clear the Custom Secure Boot Keys. Use the same Secure Boot access procedure you used to create the Custom Secure Boot Keys, but make the selection to clear or delete all Secure Boot Keys.

- a. Turn on or restart the computer, and then press **esc** while the "Press the ESC key for Startup Menu" message is displayed at the bottom of the screen.
- b. Select the **Security** menu, select **Secure Boot Configuration**, and then follow the on-screen instructions.
- c. At the **Secure Boot Configuration** window, select **Secure Boot**, select **Clear Secure Boot Keys**, and then follow the on-screen instructions to continue.

Using HP Sure Start (select models only)

Select computer models are configured with HP Sure Start, a technology that continuously monitors your computer's BIOS for attacks or corruption. If the BIOS becomes corrupted or is attacked, HP Sure Start restores the BIOS to its previously safe state, without user intervention. Those select computer models ship with HP Sure Start configured and enabled. HP Sure Start is configured and already enabled so that most users can use the HP Sure Start default configuration. The default configuration can be customized by advanced users.

To access the latest documentation on HP Sure Start, go to <http://www.hp.com/support>, and select your country. Select **Drivers & Downloads**, and then follow the on-screen instructions.

13 Power cord set requirements

The wide-range input feature of the computer permits it to operate from any line voltage from 100 to 120 volts AC, or from 220 to 240 volts AC.

The 3-conductor power cord set included with the computer meets the requirements for use in the country or region where the equipment is purchased.

Power cord sets for use in other countries and regions must meet the requirements of the country or region where the computer is used.

Requirements for all countries

The following requirements are applicable to all countries and regions:

- The length of the power cord set must be at least 1.0 m (3.3 ft) and no more than 2.0 m (6.5 ft).
- All power cord sets must be approved by an acceptable accredited agency responsible for evaluation in the country or region where the power cord set will be used.
- The power cord sets must have a minimum current capacity of 10 amps and a nominal voltage rating of 125 or 250 V AC, as required by the power system of each country or region.
- The appliance coupler must meet the mechanical configuration of an EN 60 320/IEC 320 Standard Sheet C13 connector for mating with the appliance inlet on the back of the computer. Requirements for all countries 113

Requirements for specific countries and regions

Country/region	Accredited agency	Applicable note number
Australia	EANSW	1
Austria	OVE	1
Belgium	CEBC	1
Canada	CSA	2
Denmark	DEMKO	1
Finland	FIMKO	1
France	UTE	1
Germany	VDE	1
Italy	IMQ	1
Japan	METI	3
The Netherlands	KEMA	1
Norway	NEMKO	1
The People's Republic of China	COC	5

Country/region	Accredited agency	Applicable note number
South Korea	EK	4
Sweden	CEMKO	1
Switzerland	SEV	1
Taiwan	BSMI	4
The United Kingdom	BSI	1
The United States	UL	2

1. The flexible cord must be Type H05VV-F, 3-conductor, 1.0-mm² conductor size. Power cord set fittings (appliance coupler and wall plug) must bear the certification mark of the agency responsible for evaluation in the country or region where it will be used.
2. The flexible cord must be Type SPT-3 or equivalent, No. 18 AWG, 3-conductor. The wall plug must be a two-pole grounding type with a NEMA 5-15P (15 A, 125 V) or NEMA 6-15P (15 A, 250 V) configuration.
3. The appliance coupler, flexible cord, and wall plug must bear a “T” mark and registration number in accordance with the Japanese Dentori Law. The flexible cord must be Type VCT or VCTF, 3-conductor, 1.00-mm² conductor size. The wall plug must be a two-pole grounding type with a Japanese Industrial Standard C8303 (7 A, 125 V) configuration.
4. The flexible cord must be Type RVV, 3-conductor, 0.75-mm² conductor size. Power cord set fittings (appliance coupler and wall plug) must bear the certification mark of the agency responsible for evaluation in the country or region where it will be used.
5. The flexible cord must be Type VCTF, 3-conductor, 0.75-mm² conductor size. Power cord set fittings (appliance coupler and wall plug) must bear the certification mark of the agency responsible for evaluation in the country or region where it will be used.

14 Recycling

When a non-rechargeable or rechargeable battery has reached the end of its useful life, do not dispose of the battery in general household waste. Follow the local laws and regulations in your area for battery disposal.

HP encourages customers to recycle used electronic hardware, HP original print cartridges, and rechargeable batteries. For more information about recycling programs, see the HP Web site at <http://www.hp.com/recycle>.

Index

- A**
 - AC adapter, spare part numbers 31, 33, 34
 - AC adapter/battery light 10
 - accessory battery connector, identifying 19
 - antenna
 - removal 76, 77
 - spare part numbers 28, 38, 77
 - Antenna Kit, spare part numbers 28, 38, 77
 - audio, product description 3
 - audio-in (microphone) jack, identifying 17, 18
 - audio-out (headphone) jack, identifying 17, 18
- B**
 - Backup and Restore 112
 - backup tools 110
 - backups
 - creating 111
 - recovering 112
 - base enclosure, spare part numbers 25, 35
 - battery
 - removal 48
 - spare part numbers 25, 34, 48
 - BIOS
 - determining version 95, 101
 - downloading an update 95, 102
 - updating 95, 101
 - buttons
 - left pointing stick 13
 - left TouchPad 13
 - power 15
 - right pointing stick 13
 - right TouchPad 13
- C**
 - cables, service considerations 42
 - caps lock light, identifying 14
 - card reader board
 - removal 80
 - spare part number 24, 39, 80
 - carrying case, spare part numbers 31, 33, 34
 - chipset, product description 1
 - components
 - bottom 19
 - display 9
 - front 10
 - left side 11
 - right side 17
 - top 13
 - computer
 - major components 21
 - specifications 106
 - Computer Setup
 - navigating and selecting 93, 100
 - restoring factory settings 94, 101
 - connector, power 17, 18
 - connectors, service considerations 42
- D**
 - display assembly
 - removal 71
 - spare part numbers 22, 27, 39, 71
 - display bezel
 - removal 72
 - spare part numbers 27, 34, 40, 72
 - display enclosure, spare part numbers 28, 34, 35
 - Display Hinge Kit, spare part numbers 28, 34, 35, 76
 - display panel
 - product description 1
 - removal 73
 - spare part numbers 28, 40, 74
 - display panel cable
 - removal 75
 - spare part number 28, 34, 75
 - Display Panel Support Kit, spare part numbers 28, 39
 - DisplayPort, identifying 17, 18
 - docking connector, identifying 17, 18
 - docking station, spare part number 31, 34
 - docking, product description 5
 - Driver Recovery DVD,
 - creating 110
 - using for restore 113
 - drives, preventing damage 42
- E**
 - electrostatic discharge 42
 - embedded numeric keypad, identifying 16
 - equipment guidelines 45
 - esc key, identifying 16
 - Ethernet, product description 4
 - external expansion, product description 4
 - external monitor port 11, 12
- F**
 - f11 recovery 108, 113
 - fan
 - removal 84
 - spare part numbers 24, 34, 84
 - fingerprint reader board
 - removal 89
 - spare part number 24, 34, 89
 - fingerprint reader, identifying 15
 - flash cache, product description 2
 - fn key, identifying 16
 - function keys, identifying 16
- G**
 - graphics, product description 2
 - grounding guidelines 42
 - guidelines
 - equipment 45
 - grounding 42
 - packaging 44
 - transporting 44
 - workstation 44

H

- hard drive
 - precautions 42
 - product description 3
 - removal 50
 - spare part numbers 25, 30, 34, 35, 38, 50
- hard drive bracket
 - removal 51
- hard drive connector adapter
 - removal 52
- Hard Drive Hardware Kit
 - spare part number 34
- hard drive light 10
- hard drive recovery 108, 113
- hard drive, identifying 19
- headphone (audio-out) jack 17, 18
- heat sink
 - removal 82
 - spare part numbers 24, 34, 82
- hinge
 - removal 75
 - spare part numbers 28, 34, 35, 76
- HP DisplayPort-to-HDMI 1.4 adapter,
 - spare part number 31, 34
- HP PC Hardware Diagnostics (UEFI)
 - downloading 98
 - using 98
- HP Recovery Disc Creator, using 110
- HP Recovery partition
 - checking for presence 113
 - using for recovery 113
- HP Sure Start 99, 120

I

- integrated webcam light,
 - identifying 9
- internal display switch 9
- internal microphones, identifying 9

J

- jacks
 - audio-in (microphone) 17, 18
 - audio-out (headphone) 17, 18
 - network 17, 18
 - RJ-45 (network) 17, 18

K

- keyboard
 - product description 5
 - removal 60
 - spare part numbers 22, 23, 35, 36, 37, 38, 60
- keypad 16
- keys
 - esc 16
 - fn 16
 - function 16
 - num lk 16
 - Windows applications 16
 - Windows key 16

L

- latches, service door release 19
- legacy support, USB 93, 100
- lights
 - AC adapter/battery 10
 - caps lock 14
 - hard drive 10
 - microphone mute 14
 - num lock 14
 - power 10, 14
 - RJ-45 (network) 17, 18
 - TouchPad 14
 - webcam 9
 - wireless 10, 14
- lock, spare part numbers 31, 33, 34

M

- mass storage devices
 - illustrated 30
 - precautions 42
 - spare part numbers 30
- memory
 - nonvolatile 115
 - volatile 115
- memory card reader, identifying 17, 18
- memory module
 - identifying 19
 - product description 2
 - removal 59
 - spare part numbers 25, 33, 59
- microphone
 - product description 3
- microphone (audio-in) jack,
 - identifying 17, 18

- microphone module
 - removal 74
 - spare part number 28, 34, 75
- microphone mute light, identifying 14
- MiniCard solid-state drive, product description 2
- model name 1
- mouse, spare part numbers 31, 33, 35

N

- network jack, identifying 17, 18
- NFC module
 - removal 79
 - spare part number 24, 40, 79
- nonvolatile memory 115
- num lk key, identifying 16
- num lock light 14

O

- operating system, product description 6

P

- packaging guidelines 44
- plastic parts, service considerations 41
- Plastics Kit
 - components 29
 - spare part number 29, 34
- pointing device, product description 5
- pointing stick 13
- ports
 - DisplayPort 17, 18
 - external monitor 11, 12
 - product description 5
 - USB 3.0 charging (powered) 11, 12
- power button board
 - removal 92
 - spare part number 24, 34, 92
- power button, identifying 15
- power connector, identifying 17, 18
- power cord
 - set requirements 121
 - spare part numbers 31, 32, 33, 35
- power lights 10, 14

- power requirements, product description 5
- processor, product description 1
- product description
 - audio 3
 - chipset 1
 - display panel 1
 - docking 5
 - Ethernet 4
 - external expansion 4
 - flash cache 2
 - graphics 2
 - hard drive 3
 - keyboard 5
 - memory module 2
 - microphone 3
 - MiniCard solid-state drive 2
 - operating system 6
 - pointing device 5
 - ports 5
 - power requirements 5
 - primary storage 3
 - processor 1
 - product name 1
 - security 6
 - serviceability 8
 - solid-state drive 3
 - video 3
 - wireless networking 4
- product name 1

R

- recovery 109
- recovery media, creating 110
- recovery media, using for restore 113
- recovery partition 108, 113
- recovery tools 110
- recovery tools, Windows 112
- recovery, system 112
- refresh 109
- removal/replacement
 - procedures 46, 65
- removing personal data from volatile system memory 115
- reset 109
- restoring the hard drive 108, 113
- RJ-45 (network) jack, identifying 17, 18

- RJ-45 (network) lights, identifying 17, 18
- RTC battery
 - removal 66
 - spare part number 24, 33, 66
- Rubber Kit, spare part number 25, 34

S

- Screw Kit, spare part number 32, 34
- security cable slot, identifying 11, 12
- security, product description 6
- service considerations
 - cables 42
 - connectors 42
 - plastic parts 41
- service cover
 - removal 46
 - spare part numbers 26, 39, 40, 46
- service door release latch 19
- service door release lock, identifying 19
- serviceability, product description 8
- setup utility
 - navigating and selecting 93, 100
 - restoring factory settings 94, 101
- SIM slot, identifying 20
- SIM, spare part number 31, 34
- slots
 - security cable 11, 12
 - SIM 20
- smart card reader, identifying 11, 12
- solid-state drive
 - precautions 42
 - product description 3
 - removal 55
 - spare part numbers 25, 39, 40, 55
- speaker assembly
 - removal 90
 - spare part number 24, 34, 90
- speakers, identifying 15
- specifications 106
- Startup Repair, using 112

- system board
 - removal 86
 - spare part numbers 24, 39, 40, 86
- system memory, removing personal data from volatile 115

T

- tools required 41
- top cover
 - removal 67
 - spare part numbers 24, 40, 67
- TouchPad
 - buttons 13
 - removal 78
 - spare part number 24, 40, 78
- TouchPad light, identifying 14
- TouchPad zone
 - identifying 13
- transporting guidelines 44

U

- USB 3.0 charging (powered), identifying 11, 12
- USB 3.0 port 11, 17, 18
- USB legacy support 93, 100
- USB ports, identifying 11, 17, 18

V

- vents, identifying 11, 12, 19
- video, product description 3

W

- webcam 9
- webcam light, identifying 9
- webcam, identifying 9
- webcam/microphone module
 - removal 74
 - spare part numbers 27, 40, 75
- Windows
 - Refresh 109
 - Reset 109
- Windows 7 operating system DVD
 - creating 110
 - using for restore 113
- Windows 7 operating system media
 - creating 110
 - using for restore 113
- Windows applications key, identifying 16
- Windows key, identifying 16

- Windows operating system DVD
109
- Windows Startup Repair, using 112
- wireless antenna
 - removal 76, 77
 - spare part numbers 28, 38, 77
- wireless antennas, identifying 9
- wireless light 10, 14
- wireless networking, product
description 4
- WLAN antennas, identifying 9
- WLAN module
 - removal 57
 - spare part numbers 25, 35, 40,
57
- workstation guidelines 44
- WWAN antennas, identifying 9
- WWAN module
 - removal 53
 - spare part numbers 25, 40, 53

